

Product Catalogue
2023 EDITION

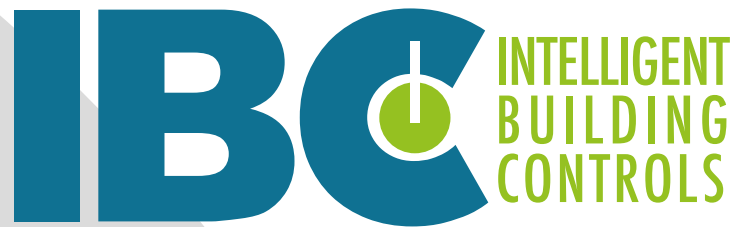

**Value added
distributor of energy
saving building
management systems
and controllers**

www.intelligentbuildingcontrols.co.uk / www.ibc.ie



about us...

Intelligent Building Controls Limited (IBC) is an Irish owned business-to-business value added distribution company, founded in 2005.

IBC is the premier independent value-added distributor and solutions provider of building energy management systems, controllers, and field devices.

IBC work with System Integrators, Alpha Architects, Builders, Developers, Contractors, Mechanical and Electrical Companies, Engineering Consultants,

Facility Managers and Facility Management Companies.

Energy efficiency is at the core of IBC's business model; providing products and systems to develop and maintain the most effective energy efficient buildings possible.

Our Mission

To be the automatic first choice supplier of Building Energy Management Systems, peripherals and software in the Republic of Ireland and Northern Ireland.

How we achieve this

IBC place major emphasis on providing premium quality and the most innovative products possible, with energy efficiency being at the core of the business model.

Contents

Controllers

- 5 EasyIO
- 7 iSMA CONTROLLI
- 13 TosiBox VPN

IO Modules

- 17 iSMA CONTROLLI
- 18 EasyIO
- 19 Axio
- 28 Sontay

Valves & Actuators

- 31 Johnson Controls
- 41 iSMA Controlli
- 46 Siemens
- 47 Goldseal
- 48 Danfoss
- 50 Industrie Technik
- 51 ESBE
- 52 Sauter
- 54 Vexve
- 54 Sontay
- 54 Xurox
- 55 Johnson /
Joventa Damper Actuators
- 57 Belimo Actuators

Meters

- 59 Onicon
- 63 Kamstrup
- 66 Danfoss
- 67 Aquamation
- 69 Vemm Tec
- 70 Sigma
- 71 Aquametro

Sensors

Temperature & Humidity

- 73 Industrie Technik
- 81 Sontay
- 91 IBC
- 92 Axio
- 93 Alre

Light & Occupancy

- 94 Sontay
- 95 Axio

Air Pressure & Velocity

- 96 Air Monitor
- 97 Sontay

Liquid Level, Flow & Pressure

- 101 Sontay

Power Sensors

- 105 Greystone, ACI,
Functional Devices Inc.

Air Quality

- 107 DriStream
- 109 GPS Air
- 111 Seitron
- 119 Sontay
- 123 Industrie Technik
- 125 Greystone
- 128 S&S Northern



Speak with our team about any large projects



Order before 2pm for same day dispatch



Speak with our expert BMS engineers today



Online training available please speak with our team

Scan the QR code to complete our online Credit Account Application Form



IBC stock over 2500 products ready for immediate delivery



Serving the (BMS & HVAC) Industry since 2005

01

BMS CONTROLLERS

Contents

Controllers

EasyIO	5
iSMA CONTROLLI	7
TosiBox VPN	13



Click the page number to
Navigate to the relevant page

EasyIO Controllers

The EasyIO F Series forms the core of these programmable controllers with features to deliver security, connectivity and programmability. **NO license fees, no recurring fees, EVER!**

- Unlicensed programming tool
- SQL Lite database
- Built-in HTML graphics
- Built-in BACnet server and client on IP and MS/TP, Modbus server on TCP, and RTU
- Supports Modbus, BACnet, TCom, RESTful API, and MQTT
- Built-in OpenVPN server/client



FS SERIES

With a 1.2 GHz quad core processor, 512MB RAM, 8GB flash memory, HTML graphics, a suite of applications and kits, and multifunctional widgets, the EasyIO FS provides unparalleled performance and allows for flexible design, enabling secure integration at both BMS and IoT levels.

Product Code	Product Information
EasyIO-FS-32	EasyIO+C6:H2O Server Class multi protocol Controller, 32 Points, 16UI, 8UO, 8DO Quad core processor, HTML5 graphics
EasyIO-FS-20	EasyIO Server Class multi protocol Controller, 20 Points, 12UI, 6UO, 2DO Quad core processor, HTML5 graphics



FW SERIES

The EasyIO FW (WiFi) series has the latest IT network and security standards and can be used as part of an existing network or as an isolated BMS network with WiFi. The FW series supports BACnet IP client/server, BACnet MSTP client/server, and Modbus TCP/ RTU M/S, as well as Sox, TCOM, P2P and MQTT. The FW series also features HTML5-ready dashboards and can be programmed live via CPT.

Product Code	Product Information
EasyIO-FW-28	EasyIO WiFi Controller, 28 Points, 16UI, 4AO, 8DO, Bacnet IP & MSTP/Modbus RTU, HTML5 dashboards
EasyIO-FW-14	EasyIO WiFi Controller, 14 Points, 8UI, 4AO, 2DO. Bacnet IP & MSTP/Modbus RTU, HTML5 dashboards
EasyIO-FW-08	EasyIO WiFi Controller, 8 Points, 4UI, 4AO, Bacnet IP & MSTP/Modbus RTU, HTML5 dashboards
EasyIO-FW-08V	EasyIO WiFi VAV Controller, 8 Points, 4UI, 4AO, built-in pressure sensor, Bacnet IP & MSTP/Modbus RTU, HTML5 dashboards
EasyIO-FW-ANT-1	Single Antenna with cable and Magnetic base
EasyIO-FW-ANT-2	Double Antenna with cable and Magnetic base



FT SERIES

The FT-04 product range is a versatile, small form factor controller. WiFi only, it can be used to extend control to hard to reach equipment, utilized in small spaces, localized lighting control, remote IO, temperature control and monitoring, on/off control of equipment, residential applications or just about anything that needs connectivity, and supports live programming and commissioning.

Product Code	Product Information
EIO-FT-04A-5	EasyIO Controller, 4 points (2 x UI, 2 x AO), Bacnet IP, WiFi, Sedona, HTML5 dashboard - 5 units
EIO-FT-04B-5	EasyIO Controller, 4 points (2 x UI, 1 x AO, 1 x DO), Bacnet IP, WiFi, Sedona, HTML5 dashboard - 5 units
EIO-FT-CLIP-5	Din-Clips 5 pieces



2 x 2.4 x .75 (inches)

EasyIO®



FC, FD SERIES AND ACCESSORIES

Product Code	Product Information
EasyIO-FC-20	The EasyIO FC-series is aimed at affordable canned solutions for stand alone applications, such as Roof Top Units, Fan Coils, AHUs, package units etc
EasyIO-FD-20i	The FD-20i provides input point expansion capacity for all FS and FW series controllers
EasyIO-FR-02	For floating control, add the optional FR-02 module, a relay module that can be din rail mounted. It allows 1 analog input from a controller to provide floating control via two built-in relays

HMI DISPLAYS

10" and 7" Android touch panels with Wi-Fi & Ethernet

Providing a slim and sleek profile for easy mounting, the device is equipped with an advanced processor for smooth and high-speed performance. These android touch panels feature a large capacitive touch screen for easy viewing.

Product Code	Product Information
EI-SH-SysView10	Touch Panel SH-SystemView10 with Wifi, Ethernet, 10 inch new design, with bracket
EI-SH-SysView7	Touch Panel SH-SystemView7 with Wifi, Ethernet, 7 inch new design, with bracket

Imagine the possibilities— and make them real



Discover a breakthrough approach to controlling systems and buildings. Use the EasyIO platform to control an application or an entire system, a piece of equipment or an entire plant, a room or an entire building. With open standards and open source features, EasyIO helps deliver optimal facility performance.

iSMA CONTROLLI SYSTEM

Powered by Niagara the iSMA-B-MAC36NL hybrid IoT controller with 36 I/O, HDMI port, 2 USB and RS485 port, provides control, data logging, alarming, scheduling, integration and visualization and can work as standalone mini-BMS supervisory controller.

With protocols like BACnet IP, Modbus TCP, LON IP, M-Bus IP, etc. all supported, the iSMA-B-MAC36NL offers endless possibilities of integration between different systems like HVAC, access control, lighting, CCTV, and many others.

MAC36NL CONTROLLERS

Product Code	Product Information
iSMA-B-MAC36NL	Controller hardware, 1xRS485, 2xETH, 2xUSB, 1xHDMI, 1xSD card slot, 16xUI, 4xDI, 8xDO, 8xAO. Power supply 24 V AC/DC.
iSMA-B-MAC36NL-RS	Controller hardware, 2xRS485, 2xETH, 2xUSB, 1xHDMI, 1xSD card slot, 16UI, 4DI, 8DO, 8AO. Power supply 24 V AC/DC.
iSMA-B-MAC36NL-M	Controller hardware, 1x M-Bus, 1xRS485, 2xETH, 2xUSB, 1xHDMI, 1xSD card slot, 16xUI, 4xDI, 8xDO, 8xAO. Power supply 24 V AC/DC.
iSMA-B-SD-NL	SD card dedicated for iSMA-B-MAC36NL controllers. Used to store and move configuration files and licenses. Required to start the controller.

Standard software models include Open Drivers: BACnet IP and MSTP, LON, KNX-IP, M-bus, Modbus all types, oBiX, OpenADR, SNMP, Z-Wave. BUILT-IN 36 I/O - do not reduce the core license capacity. The Initial 18 months maintenance license is mandatory to order. It is not required to renew after it expires

Product Code	Product Information
iSMA-B-MAC-L-100	Niagara Core License for iSMA-B-MAC Controllers - 100 Niagara Proxy Points (requires iSMA-B-MAC-100-M0 maintenance)
iSMA-B-MAC-100-M0	iSMA-B-MAC-L-100 - Initial 18 month maintenance. Must be purchased in conjunction with initial Core software. Optional 3 or 5 year maintenance may be substituted.
iSMA-B-MAC-L-250	Niagara Core License for iSMA-B-MAC Controllers - 250 Niagara Proxy Points (requires iSMA-B-MAC-250-M0 maintenance)
iSMA-B-MAC-250-M0	iSMA-B-MAC-L-250 - Initial 18 month maintenance. Must be purchased in conjunction with initial Core software. Optional 3 or 5 year maintenance may be substituted.
iSMA-B-MAC-L-500	Niagara Core License for iSMA-B-MAC Controllers - 500 Niagara Proxy Points (requires iSMA-B-MAC-500-M0 maintenance)
iSMA-B-MAC-500-M0	iSMA-B-MAC-L-500 - Initial 18 month maintenance. Must be purchased in conjunction with initial Core software. Optional 3 or 5 year maintenance may be substituted.
iSMA-B-MAC-L-1250	Niagara Core License for iSMA-B-MAC Controllers - 1250 Niagara Proxy Points (requires iSMA-B-MAC-1250-M0 maintenance)
iSMA-B-MAC-1250-M0	iSMA-B-MAC-L-1250 - Initial 18 month maintenance. Must be purchased in conjunction with initial Core software. Optional 3 or 5 year maintenance may be substituted.

DEMO EQUIPMENT

Product Code	Product Information
iSMA-B-MAC-L-DEMO	iSMA-MAC36NL controller with unlimited points and protocols, for partner engineering and demo use only. Not for end user sales. 18 months Initial maintenance included.

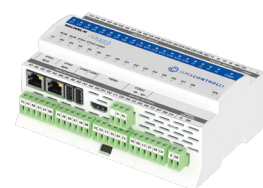

powered by
niagara
 framework®

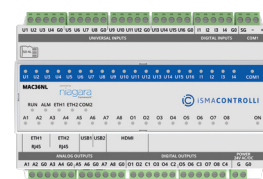



JACE 8000

This JACE 8000 controller leverages all of the features of the Niagara Framework®. It adds to the enhanced user experience, maximizing Niagara's advantages in delivering HTML5 views, charting, and other aspects of data visualization. It offers robust security and improved device management capabilities. With a simple configuration, toolless installation, low-cost integration, and high-powered performance, the JACE 8000 controller is a radical evolution in connecting and controlling devices worldwide.

Product Code	Product Information
iSMA-B-J8-100	JACE-8000 controller with capacity of 100 Proxy Points, 18 months Initial maintenance included.
iSMA-B-J8-250	JACE-8000 controller with capacity of 250 Proxy Points, 18 months Initial maintenance included.
iSMA-B-J8-500	JACE-8000 controller with capacity of 500 Proxy Points, 18 months Initial maintenance included.

EDGE 10

The Edge 10 is an IP-based field equipment controller, also powered by the Niagara Framework®. Niagara Edge 10 controllers drive applications such as zone temperature control, and the operation of fan coil units, single stage air handling units, water-source heat pumps and more. Niagara Edge 10 controllers run the full Niagara stack, with 10 points of on-board IO and IO-R-34 expansion capability.



Product Code	Product Information
iSMA-B-EDGE-10	Niagara Edge 10 field controller with 10 points of onboard IO, 1 RS-485 serial port, and 2 10/100 Ethernet ports. Includes Niagara N4 and drivers for BACnet, Modbus and SNMP. Supports up to 3 devices and 50 total points. Tridium EMEA Branded.

powered by
niagara
framework®



iSMACONTROLLI

Powered by
sedona
FRAMEWORK™



LICENSED & FREWARE SOFTWARE BUNDLES



The new MAX Multiprotocol I/O Modules

Coming soon!

3x
Faster installation
Easier to maintain
Less cabling
The Same great features!

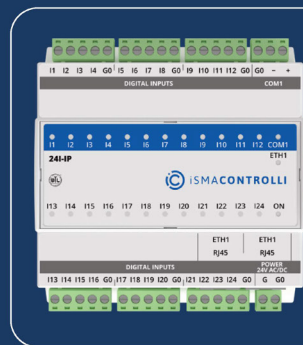
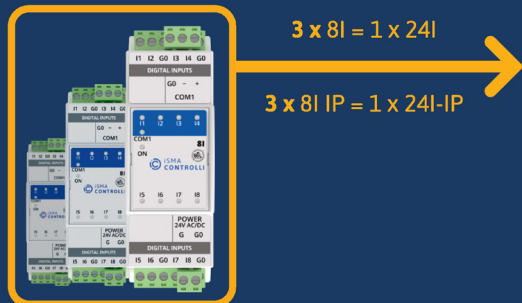

120-H and 120-H-IP key features

Multiprotocol I/O Modules
with maximum number of digital outputs

Manual Override Switches
Each output can be manually overridden using a dedicated hand operating switch.

12 Digital Outputs
Digital outputs equipped with NO 3 A relays allow for direct control of HVAC applications.

Ethernet interface with built-in switch
Two Ethernet ports working in a switch mode allow for daisy chaining multiple modules over RJ45, which enhances the cabling process and reduces engineering time.

Open Protocols Standard
MAX I/O modules work as remote or distributed I/Os over IP or RS485 with open protocols: BACnet and Modbus.

Open protocols standard
offers a versatility of installing the modules in both new and existing facilities, whether it is a system expansion or a retrofit.

Modbus TCP/IP to Modbus RTU/ASCII Gateway
Built-in Modbus gateway on the COM1 port enables integration of up to 128 Modbus slave devices to the IP layer.

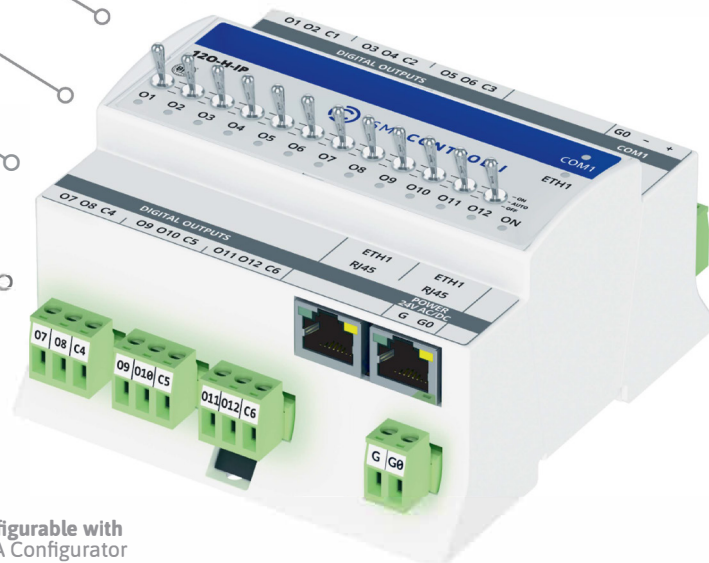

Configurable with iSMA Configurator



HMI DISPLAYS

Product Code	Product Information
iSMA-D-PD10C-B1-UK	10.1" LCD touch display, 10-point touch screen, Aspect Ratio 16:9, 1366x768 resolution, 1xHDMI, 1xVGA, 1xDVI, 1xI/O Audio, 1xRJ45-USB for touch input. Aluminium alloy housing in black with laser-printed "ISMA" logo. DC power supply 12 V or 24 V (AC power supply 110-240 V included - UK plug type)
iSMA-D-PA7C-B1-UK	7-inch screen panel PC with Android. Built-in iSMA application with user management functions and "Kiosk Mode". 10 point touch screen (CTP), 16:9 aspect ratio, 1024x600 resolution, 250 nit standard brightness. Built-in: WiFi, 1xRJ45, 2xRS232, 3xUSB, 1xHDMI, 1xTF/SD. Aluminium alloy housing in black with laser-printed logo, VESA compliant. Power supply 12 V DC, (110 V - 240 V AC power supply included - UK plug type).
iSMA-D-PA10C-B1-UK	10.1-inch screen panel PC with Android. Built-in iSMA application with user management functions and "Kiosk Mode". 10-point capacitive touch panel (CTP), screen Aspect Ratio 16:9, Resolution 1366x768, standard luminance 300nit. Built-in: 1xRJ45, 2xRS232, 2xUSB, 1xTF/SD card. Black colour aluminium alloy housing material with laser printed 'ISMA' logo, VESA compliant. Power supply 12 V DC (110 V - 240 V AC power supply included - UK plug type).
iSMA-D-PA15C-B1-UK	15.6-inch screen panel PC with Android. Built-in iSMA application with user management functions and "Kiosk Mode", 10-point capacitive touch panel (CTP), screen Aspect Ratio 16:9, Resolution 1920x1080, standard luminance 300nit. Built-in: 1xRJ45, 2xRS232, 2xUSB, 1xTF/SD. Black colour aluminium alloy housing material with laser printed 'ISMA' logo, VESA compliant. Power supply 12 V DC (110 V - 240 V AC power supply included - UK plug type).
iSMA-D-PEN-ACC	HMI screens accessory: Stylus for capacitive displays. Magnetic and self-adhesive holder included.

iSMA TOOL FOR SEDONA FREWARE CONTROLLERS

Product Code	Product Information
iSMA-B-CH-TR-1Y	Annual Support fee and renewal of Demo equipment and Workbench licenses for partner. The accounting period is fixed, each year begins on 1 March. In the absence of payment for the next period, all Demo licenses expire at the end of February.
iSMA-B-CH-TR-1M	"Annual Support fee and renewal of Demo equipment and Workbench licenses for partner. Per month in first year before renewal."







Training at IBC

ONLINE | IN-PERSON | PRODUCT SUPPORT

TRAINING@IBC.IE

RAC CONTROLLERS

With 18 I/O's on board, the RAC18-IP is a multifunctional device providing comfort in a single room or zone and, thanks to the built-in Nano EDGE ENGINE cutting-edge software, the controller can work on multiple applications simultaneously.

RAC offers a set of libraries and components tailored to create cycle-driven user applications and provides an automatic BACnet exposure and real-time programming. Maintenance and programming of the device are possible from anywhere in real time with a dedicated, free-of-charge tool. The RAC18-IP ensures an easy replacement process with a system and applications on a removable SD card.

Product Code	Product Information
RAC18-IP	Free programmable Room Application Controller, 1xRS485, 2xETH (fail-safe protected), 1xUSB, 4xUI, 4xDI, 5xDO, 3xAO, 2xTO. Power supply 24 V AC/DC.

AAC20 SEDONA FRAMEWORK FREELY PROGRAMMABLE CONTROLLER

The iSMA-B-AAC20 controller is equipped with 22 I/O. The application for control algorithm can be created and modified in real-time by free software iSMA Tool or by standard Niagara AX Workbench. As an Integration Controller, iSMA-B-AAC20 can be a platform for integration and control of Modbus (RTU, ASCII, TCP), BACnet (MS/TP, IP), 1-Wire, M-BUS (Option) and DALI (Option) devices. This controller has 2x Fast Ethernet ports with switch mode.

Product Code	Product Information
iSMA-B-AAC20	Free programmable Advanced Application Controller, 1xRS485, 2xETH, 1x1-Wire, 1xUSB, 8xUI, 4xDI, 4xDO, 4/6x AO. Power supply 24 V AC/DC.
iSMA-B-AAC20-D	Free programmable Advanced Application Controller, 1xRS485, 2xETH, 1x1-Wire, 1xUSB, 1xDALI (built-in power supply max.130 mA), 8xUI, 4xDI, 4xDO, 4/6x AO. Power supply 24 V AC/DC.
iSMA-B-AAC20-M	Free programmable Advanced Application Controller, 1xRS485, 2xETH, 1x1-Wire, 1xUSB, 1xM-Bus interface (built-in power supply up to 20 meters), 8xUI, 4xDI, 4xDO, 4/6x AO. Power supply 24 V AC/DC.
iSMA-B-AAC20-LCD	Free programmable Advanced Application Controller with LCD, 1xRS485, 2xETH, 1x1-Wire, 1xUSB, 8xUI, 4xDI, 4xDO, 4/6x AO. Power supply 24 V AC/DC.
iSMA-B-AAC20-LCD-D	Free programmable Advanced Application Controller with LCD, 1xRS485, 2xETH, 1x1-Wire, 1xUSB, 1xDALI (built-in power supply max.130 mA), 8xUI, 4xDI, 4xDO, 4/6x AO. Power supply 24 V AC/DC.
iSMA-B-AAC20-LCD-M	Free programmable Advanced Application Controller with LCD, 1xRS485, 2xETH, 1x1-Wire, 1xUSB, 1xM-Bus interface (built-in power supply up to 20 meters), 8xUI, 4xDI, 4xDO, 4/6x AO. Power supply 24 V AC/DC.

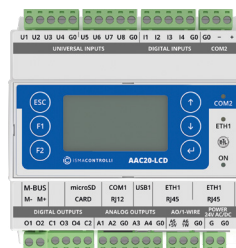
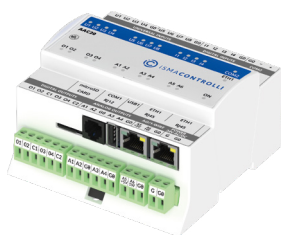

powered by functionalities

iSMA-B-AAC20

HVAC & Plant Control Solution



sedona

FRAMEWORK™

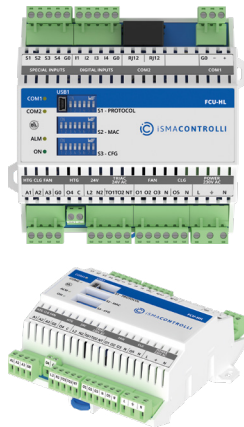

FCU

The fully programmable controller iSMA-B-FCU-HH, is built with the aim of controlling the FCU. The controller is factory-equipped with the two most popular open communication protocols Modbus ASCII/RTU and BACnet MSTP, which are selected using DIP switches. To minimise time and simplify commissioning process the iSMA-B-FCU-HH controller is delivered with universal application, which supports the most popular types of FCU.

In the case, if the application does not meet the project requirements, it can be modified or created from scratch. Changing of the application is possible in real-time by USB. There are three hardware versions which have different types of Triac Outputs and power supply.

Product Code	Product Information
iSMA-B-FCU-HH	Configurable/Free programmable fan-coil unit controller with Modbus RTU or BACnet MS/TP communication. Build-In: 4xDI, 4xSI, 1xDO-HTG (10 A), 1xDO-CLG (6 A), 3xDO-FAN (6A@230 V AC), 2xTO (0,5 A@230 V AC), 3xAO. Power supply 230 V AC.
iSMA-B-FCU-HL	Configurable/Free programmable fan-coil unit controller with Modbus RTU or BACnet MS/TP communication. Build-In: 4DI, 4SI, 1Do-HTG (10 A), 1Do-CLG (6 A), 3Do-FAN (6 A@230 V AC), 2xTO (0,3 A@24 V AC), 3AO. Power supply 230 V AC.
iSMA-B-FCU-LL	Configurable/Free programmable fan-coil unit controller with Modbus RTU or BACnet MS/TP communication. Build-In: 4xDI, 4xSI, 1xDO-HTG (10 A), 1xDO-CLG (6 A), 3xDO-FAN (6 A@24 V AC), 2xTO (0,5 A@24 V AC), 3XAO. Power supply 24 V AC.

TSP

iSMA-B-TSP colour touch screen panel is fully programmable panel/controller ideal for managing a wide range of individual building products such as FCU, VAV, Lighting, Blinds, Windows. Extremely flexible customization options are available thanks to configurable colour touch screen, full programmability, and custom logo placement options.

In addition to RS485 which is used to connect device to BMS/HMS systems it has been equipped with additional RS485 which can be used to direct control of other devices like I/O modules (MIX, MINI, Wireless). In addition to basic fan-speed and temperature settings, lighting controls can easily be integrated, as well as custom application specific functions (e.g. Do Not Disturb / Make Up Room buttons for hotel rooms).

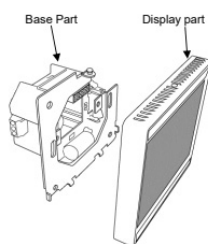

Product Code	Product Information
iSMA-B-TSP-RS2-S-D-B/W	Free programmable controller, built-in 3.5" touch LCD screen. Communication BACnet MSTP/Modbus RTU. Power supply 24 V AC/DC. 2xRS485, 1xDALI/DMX. Built-in temperature sensor. Mounting base required. Frame colour - Black or White
iSMA-B-TSP-RH2-S-D-B/W	Free programmable controller, built-in 3.5" touch LCD screen. Communication BACnet MSTP/Modbus RTU. Power supply 24 V AC/DC. 2xRS485, 1xDALI/DMX. Built-in temperature and humidity sensor. Mounting base required. Frame colour - Black
iSMA-B-TSP-RS2-S-DB-B/W	Free programmable controller, built-in 3.5" touch LCD screen. Communication BACnet MSTP/Modbus RTU and MP-Bus. Power supply 24 V AC/DC. 2xRS485, 1xDALI/DMX. Built-in temperature sensor. Mounting base required. Frame colour - Black
iSMA-B-TSP-RH2-S-DB-B/W	Free programmable controller, built-in 3.5" touch LCD screen. Communication BACnet MSTP/Modbus RTU and MP-Bus. Power supply 24 V AC/DC. 2xRS485, 1xDALI/DMX. Built-in temperature and humidity sensor. Mounting base required. Frame colour - Black
iSMA-B-TSP-B2F-B/W	Mounting base for iSMA-B-TSP controllers with WiFi interface, mounting to an electrical box.
iSMA-B-TSP-B2F	Mounting base for iSMA-B-TSP controllers, mounting to an electrical box.
iSMA-B-TSP-B2S-B/W	Mounting base for iSMA-B-TSP controllers, surface-mounting - Black or White

TOSIBOX® Lock 150



Compliance with
 IMDA Standards
 DB107332



TOSIBOX® Lock 150 is an industrial router with firewall and secure Plug & Go™ connectivity. It serves as an endpoint for secure remote connections.

IoT devices connected to the Lock can be securely accessed over the Internet and most LAN and WAN networks through an encrypted VPN connection. TOSIBOX® Lock 150 is compatible with all existing TOSIBOX® products.

Technical data

Product codes
 TBL15

Ports

- 1 x USB 2.0, type A
- 1 x RJ-45 WAN connection, 10/100 Mb/s, auto-negotiation (MDI / MDI-X)
- 3 x RJ-45 LAN connection, 10/100 Mb/s, auto-negotiation (MDI / MDI-X)
- x RJ-45 Service connection, 10/100 Mb/s, auto-negotiation (MDI / MDI-X)

Connections

- 10-30V DC ±10% (reverse polarity protected)
- 2 x Wireless network antenna connector, RP-SMA Female
- DIN rail attachment (bottom), angle bracket available as an accessory (TBMBD1)

WAN connection features

- Independent of operating systems
- Works in all Internet connections (operator independent)
- Supports HTTP proxy servers with and without authentication
- Firewall friendly
- Works with dynamic, static and private IP addresses
- Built-in firewall, NAT
- Up to 10 concurrent VPN connections
- VPN throughput 10 Mb/s

Mobile connection features

- Supported 4G USB modems: TOSIBOX® 4G modem

- TosiOnline™ Automatic network recovery that recovers from most mobile operator and modem problems

WLAN

- IEEE 802.11 b/g/n, max. 150 Mbps
- WEP, WPA-PSK, WPA2-PSK, WPA-PSK/WPA2-PSK Mixed encryption
- Frequency 2.412 – 2.462 GHz, 11 channels
- Output power 20 dBm max

Included accessories

- RJ-45 Cat6 Ethernet cable, USB extension cable
- 2 x WLAN antennas, 2 dBi
- AC Adapter: Input 100 – 240V AC, frequency 47 – 63 Hz, Output 24.0 V, 0.8 A, max 7.2 W. EU, UK, AU or US Power Socket
- DC input plug
- DIN rail mounting bracket

Physical properties

- 132 mm x 99 mm x 35.5 mm / 5.2" x 3.9" x 1.4" (L x W x H)
- Weight 593 g / 1.31 lbs (net weight article)
- Cast aluminium casing
- Operating temperature -20 °C ... +55 °C / -4 °F ... 131 °F
- Operating humidity: 20 – 80% RH, non-condensing
- Storage temperature -40 °C ... +70 °C / -40 °F ... 158 °F
- Protection class IP20



TOSIBOX

TOSIBOX



TOSIBOX

TOSIBOX® Virtual Central Lock is an operative network for your devices and service personnel. The Virtual Central Lock turns your TOSIBOX® ecosystem into a controlled OT network of always-on VPN connections for remote maintenance, continuous monitoring, real-time data collection and data logging.

TOSIBOX® STARTER KITS

Product Code	Product Name	Product Information
TBKIT150	Starterkit 150 (Europe)	1 pcs Lock Lock 150 + 1 pcs Tosibox Key + 1 pcs SoftKey (European version)
TBKIT175	Starterkit 175	1 pcs Tosibox 175 + 1 pcs Tosibox Key + 1 pcs SoftKey (Global version)
TBKIT210	Starterkit 210	1 pcs Lock Lock 210 + 1 pcs Tosibox Key + 1 pcs SoftKey
TBKIT500A	Starterkit 500 (Europe)	1 pcs Lock Lock 500i incl 4G modem + 1 pcs Tosibox Key + 1 pcs SoftKey (European version)
TBKIT610UK	Starterkit 610 (UK)	1 pcs Tosibox 610 + 1 pcs Tosibox Key + 1 pcs SoftKey (UK version)
TBKIT675UK	Starterkit 675 (UK)	1 pcs Tosibox 675 + 1 pcs Tosibox Key + 1 pcs SoftKey (UK version)

TOSIBOX® KEY OPTIONS

Product Code	Product Name	Product Information
TBK2	TOSIBOX® KEY	with Mobile Client
TBSKL1	TOSIBOX® SOFTKEY LICENSE	1 piece (also available in 5 pieces / 10 pieces)
TBMC1	TOSIBOX® MOBILE CLIENT	1 piece (also available in 5 pieces / 10 pieces)

TOSIBOX® NODES

Product Code	Product Name	Product Information
TBL175	TOSIBOX® 175	Built-in 4G modem, WAN, LAN, WiFi. Throughput 70 Mbit/s. 4 year Perpetual License.
TBL610UK	TOSIBOX® 610	WAN, LAN. Throughput 70 Mbit/s. 4 year Perpetual License.
TBL650UK	TOSIBOX® 650	WAN, LAN, WiFi. Throughput 70 Mbit/s. 4 year Perpetual License.
TBL670UK	TOSIBOX® 670	Built-in 4G modem*2 SIM slots, WAN, LAN. Throughput 70 Mbit/s. 4 year Perpetual License.
TBL675UK	TOSIBOX® 675	Built-in 4G modem*2 SIM slots, WAN, LAN, WiFi. Throughput 70 Mbit/s. 4 year Perpetual License.
TBNODEM	Additional Maintenance Fee	Extended maintenance after 4 years for TOSIBOX® Nodes in remote access use. <ul style="list-style-type: none"> • Not needed with VCL Nodes • for 1 year (annual fee)

TOSIBOX® LOCKS

Product Code	Product Name	Product Information
TBL15	TOSIBOX® LOCK 150	with EU, UK, AU, US power connector
TBL21	TOSIBOX® LOCK 210	with or without power source
TBL25	TOSIBOX® LOCK 250	with or without power source, integrated WiFi
TBL5	TOSIBOX® LOCK 500	with or without power source
TBL5iA	TOSIBOX® LOCK 500i (EU/US)	with or without power source
TBL5iB	TOSIBOX® LOCK 500i (APAC)	with or without power source
TBL5iC	TOSIBOX® LOCK 500i (USA/CAN/EMEA)	with or without power source



TOSIBOX® ACCESSORIES

Product Code	Product Name	Product Information
TB3GM2M	3G USB-Modem, Huawei	with one antenna connector
TBRFA-CRC9	Adapter Cable	3G Huawei modem to antenna
TB4GM	4G USB-Modem, Alcatel	with two antenna connectors
TBRFA-TS9	Adapter Cable	Adapter cable used with Alcatel 4G modem for antenna connection
TBANT1	Antenna, external	omni-directional with 8m cable
TBANT2	Antenna, external, magnet	omni-directional with 3m cable
TBAEC-L5	Antenna Extension Cable	Length 5m
TBAEC-L10		Length 10m



TOSIBOX® CONNECTION ADAPTERS

Product Code	Product Name	Product Information
TBPBA1	Profibus Adapter	PROFIBUS Ethernet Gateway – MPI/PPI/PROFIBUS
TBRSA2	Moxa, NPort 5110	1-port RS-232 serial device
TBL5-AP1	Accessory Pack Lock 500 (EMEA/APAC)	Including: 2 X WiFi antenna, 2 x LTE antenna, AC adapter including EU, UK, US/JP, AUS connectors and DC feed cable
TBL5-AP2	Accessory Pack Lock 500 (USA/CAN)	Including: 2 X WiFi antenna, 2 x LTE antenna, AC adapter including EU, UK, US/JP, AUS connectors and DC feed cable
TBMBD1	DIN-mounting Bracket	for TOSIBOX® Lock 100/150



IBC stock over 2500 products ready for immediate delivery



Serving the (BMS & HVAC) Industry since 2005

02

IO MODULES

Contents

IO Modules

iSMA CONTROLLI	17
EasyIO	18
Axio	19
Sontay	28



Click the page number to
Navigate to the relevant page

iSMA CONTROLLI

All the MIX Series modules have been equipped with a MIX of the most commonly used types of I/O in building automation, and are factory-equipped with the two most popular open communication protocols: Modbus (ASCII, RTU, TCP/IP) and BACnet (MSTP, IP), which are selected using DIP switches.

There are two versions of the modules, namely: modules with interface RS485, and modules with interfaces 2x Ethernet and RS485. Devices with interfaces 2x Ethernet and RS485 have the added functionality of “Modbus Gateway TCP/IP to Modbus ASCII/RTU”, enabling you to connect additional modules/devices that communicate via Modbus RS485. The MIX38 is one of the most space saving solutions on the market, with 38x IO on board and measuring only 160x110x62 mm. The Universal Inputs support Temperature, Resistance, Voltage, and Current (or dry contact type of the input signal).

MIX SERIES I/O WITH RS485

Product Code	Product Information
iSMA-B-MIX18	I/O module with Modbus RTU/ASCII or BACnet MSTP communication. 1xRS485, 5xDI, 5xUI, 4xAO, 4xDO. Power supply 24 V AC/DC.
iSMA-B-MIX18-IP	I/O module with Modbus TCP/IP (with built in Modbus Gateway to RS485) or BACnetIP communication. 2xETH, 1xRS485, 5xDI, 5xUI, 4xAO, 4xDO. Power supply 24 V AC/DC.

MIX SERIES I/O WITH IP AND RS485

Product Code	Product Information
iSMA-B-MIX38	I/O module with Modbus RTU/ASCII or BACnet MSTP communication. 1xRS485, 12xDI, 8xUI, 6xAO, 12xDO. Power supply 24 V AC/DC.
iSMA-B-MIX38-IP	I/O module with Modbus TCP/IP (with built in Modbus Gateway to RS485) or BACnetIP communication. 2xETH, 1xRS485, 12xDI, 8xUI, 6xAO, 12xDO. Power supply 24 V AC/DC.

The MINI series has been designed to complement the I/O modules of the MIX series and contains 7 different types of modules. Like in case of the MIX modules, the modules are factory-equipped with the two most popular open communication protocols: Modbus (ASCII, RTU, TCP/IP) and BACnet (MSTP, IP), which are selected using DIP switches.

There are two versions of the modules, namely: modules with interface RS485, and modules with interfaces Ethernet and RS485. Devices with interfaces Ethernet and RS485 have the added functionality of “Modbus Gateway TCP/IP to Modbus ASCII/RTU”, enabling you to connect additional modules / devices which communicate via Modbus RS485. The MINI modules can have additional switches (DO) or potentiometers (AO) for overriding the outputs locally (Hand Control).

MINI SERIES I/O WITH RS485

Product Code	Product Information
iSMA-B-8I	I/O module with Modbus RTU/ASCII or BACnet MSTP communication. 1xRS485, 8xDI. Power supply 24 V AC/DC.
iSMA-B-8U	I/O module with Modbus RTU/ASCII or BACnet MSTP communication. 1xRS485, 8xUI. Power supply 24 V AC/DC.
iSMA-B-4I4O-H	I/O module with Modbus RTU/ASCII or BACnet MSTP communication. 1xRS485, 4xDI, 4xDO with hand operating. Power supply 24 V AC/DC.
iSMA-B-4U4O-H	I/O module with Modbus RTU/ASCII or BACnet MSTP communication. 1xRS485, 4xUI, 4xDO with hand operating. Power supply 24 V AC/DC.
iSMA-B-4U4A-H	I/O module with Modbus RTU/ASCII or BACnet MSTP communication. 1xRS485, 4xUI, 4xAO with hand operating. Power supply 24 V AC/DC.
iSMA-B-4O-H	I/O module with Modbus RTU/ASCII or BACnet MSTP communication. 1xRS485, 4xDO NC/NO max. 8 A @ 230 V AC/30 V DC relay with hand operating. Power supply 24 V AC/DC.
iSMA-B-4TO-H	I/O module with Modbus RTU/ASCII or BACnet MSTP communication. 1xRS485, 4xTO triac outputs max. 0,5 A @ 230 V AC /24 V AC with hand operating. Power supply 24 V AC/DC.

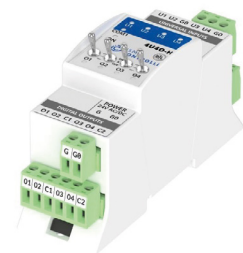
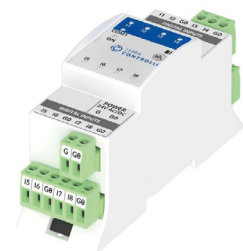
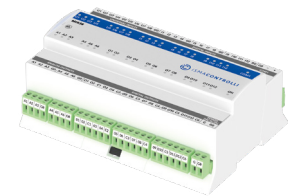
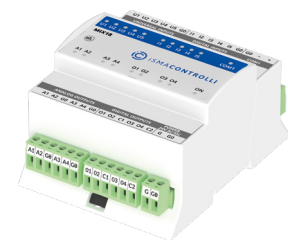

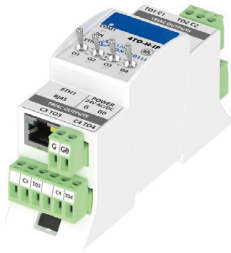
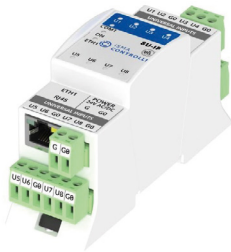

MINI SERIES I/O WITH IP AND RS485

Product Code	Product Information
iSMA-B-8I-IP	I/O module with Modbus TCP/IP (with built in Modbus Gateway to RS485) or BACnetIP communication. 1xETH, 1xRS485, 8xDI. Power supply 24 V AC/DC.
iSMA-B-8U-IP	I/O module with Modbus TCP/IP (with built in Modbus Gateway to RS485) or BACnetIP communication. 1xETH, 1xRS485, 8xUI. Power supply 24 V AC/DC.
iSMA-B-4I4O-H-IP	I/O module with Modbus TCP/IP (with built in Modbus Gateway to RS485) or BACnetIP communication. 1xETH, 1xRS485, 4xDI, 4xDO with hand operating. Power supply 24 V AC/DC.
iSMA-B-4U4O-H-IP	I/O module with Modbus TCP/IP (with built in Modbus Gateway to RS485) or BACnetIP communication. 1xETH, 1xRS485, 4xUI, 4xDO with hand operating. Power supply 24 V AC/DC.
iSMA-B-4U4A-H-IP	I/O module with Modbus TCP/IP (with built in Modbus Gateway to RS485) or BACnetIP communication. 1xETH, 1xRS485, 4xUI 4xAO with hand operating. Power supply 24 V AC/DC.
iSMA-B-4O-H-IP	I/O module with Modbus TCP/IP (with built in Modbus Gateway to RS485) or BACnetIP communication. 1xETH, 1xRS485, 4xDO NO/NC max. 8 A @ 230 V AC/30 V DC relay with hand operating. Power supply 24 V AC/DC.
iSMA-B-4TO-H-IP	I/O module with Modbus TCP/IP (with built in Modbus Gateway to RS485) or BACnetIP communication. 1xETH, 1xRS485, 4xTO triac outputs max. 0,5 A @ 230 V AC /24 V AC triac with hand operating. Power supply 24 V AC/DC.

WIRELESS I/O

Product Code	Product Information
iSMA-B-W0202	Wireless Bridge for Modbus RTU/ASCII. 1xRS485, 2xSI, 2xDO. Power supply 24 V AC/DC.
iSMA-B-WEXTA	iSMA-B-W0202 optional antenna - signal gain 5 dBi.
iSMA-B-WEXT2	An extension cable 2-meter length for wireless modules.
iSMA-B-WEXT5	An extension cable 5-meter length for wireless modules.

GATEWAYS

Product Code	Product Information
iSMA-B-MG-IP	Meter Gateway with built-in M-Bus gateway (power supply for up to 60 devices) and Modbus TCP/IP to Modbus RS485 gateway. 1x RS485, 1xETH, 1xM-Bus. Power supply 24 V AC/DC.

FC, FD SERIES AND ACCESSORIES

Product Code	Product Information
EasyIO-FC-20	The EasyIO FC-series is aimed at affordable canned solutions for stand alone applications, such as Roof Top Units, Fan Coils, AHUs, package units etc
EasyIO-FD-20i	The FD-20i provides input point expansion capacity for all FS and FW series controllers
EasyIO-FR-02	For floating control, add the optional FR-02 module, a relay module that can be din rail mounted. It allows 1 analog input from a controller to provide floating control via two built-in relays

AXIO ANNICOM

Annicom has been established as a design and build company for the Industrial Controls, HVAC, and Building Automation Industry for more than 25 years.

Alongside its own range of high quality products under the AXIO brand name it also designs and manufactures controls for many of the industry giants on an OEM basis. All components used in Annicom's production facility meet its stringent Quality Assurance guidelines, are RoHS & CE compliant where required, and are fully tested before leaving the factory.

DIGITAL INPUT MULTIPLEXER

Product Code	Product Information
HC-DIM4-MI	4 x digital input (VFC) multiplexer 0-10VDC output Din Rail module trend compatible output with built in offset (direct equivalent to trend) and other input versions.
HC-DIM6-MI	6 x digital input (VFC) multiplexer 0-10VDC output Din Rail module trend compatible output with built in offset (direct equivalent to trend) and other input versions.

SINGLE RELAY MODULE

Product Code	Product Information
HC-RM1F	Single relay Din Rail module with fixed switch point. 0-10VDC input 24VAC powered fixed switchpoint at 5VDC.

SINGLE RELAY MODULE C/W ADJUSTMENT

Product Code	Product Information
HC-RM1AB	adjustment and also buffered output. 0-10VDC input 24VAC powered.

RESISTANCE INPUT MODULES

Product Code	Product Information
HC-RIM135	Resistance input module 135 OHMS to 0-10VDC. Powered from a 24VAC/DC supply. LED indicators.
HC-RIM-1K	Resistance input module 1,000 (1K) to 0-10VDC. Powered from a 24VAC/DC supply. LED indicators.

TWO RELAY MODULE

Product Code	Product Information
HC-RM2T	2 stage relay module with timer. Din Rail module raise/lower, high/low & binary 0-10VDC input. 24VAC/DC powered.

THREE RELAY MODULE

Product Code	Product Information
HC-RM3M	3 stage relay Din Rail module (0-10VDC input) adjustable time delay. 24VAC/DC powered.

AXIO

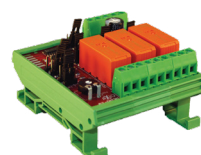
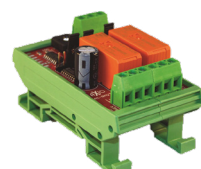
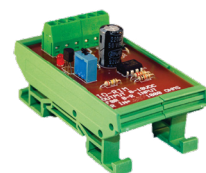
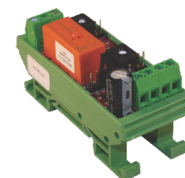
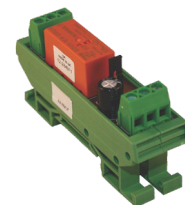

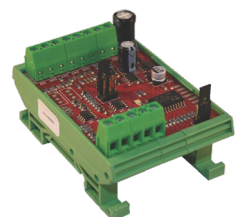
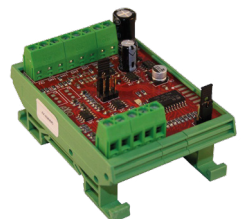
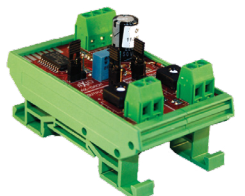
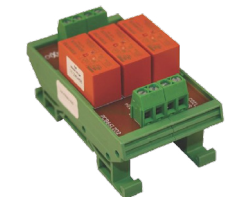
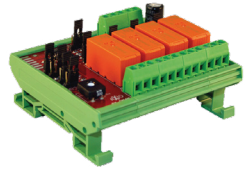
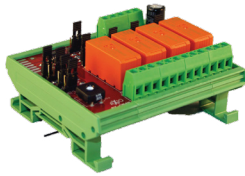

FOUR RELAY MODULE

Product Code	Product Information
HC-RM4M	4 stage relay Din Rail module (0-10VDC input). 24VAC/DC powered.

FOUR RELAY MODULE C/W ADJUSTMENT

Product Code	Product Information
HC-RM4AB	4 stage relay module with adjustable switchpoints. On and off switch points for each relay. (0-10VDC input) 24VAC/DC powered.

SIX RELAY MODULE

Product Code	Product Information
HC-RM6M	6 stage relay Din Rail module (0-10VDC input). 24VAC/DC powered.

FAN SPEED RELAY MODULE

Product Code	Product Description	Product Information
HC-FRM3-24	Fan Speed Controller	Fan speed relay module either in 24V or 230V versions. Designed for fan switching applications.
HC-FRM3-230	Fan Speed Controller	Fan speed relay module either in 24V or 230V versions. Designed for fan switching applications.

IP65 ENCLOSURE AVAILABLE ON REQUEST

DUAL ANALOGUE OUTPUT MODULE

Product Code	Product Information
HC-DAOM	Dual analogue output module, converts a 0-10VDC or 2-10VDC input signal to 2 x 0-10VDC or 2 x 2-10VDC output signals. 24VAC/DC powered.

AVERAGING MODULE

Product Code	Product Description	Product Information
HC-AMMM	4 Ch Min, Max And Averaging Module	Provides the average minimum, maximum and middle values of the selected 0-10V inputs, up to 5 inputs can be selected. 24VAC/DC powered.

ANALOGUE INPUT MULTIPLEXER

Product Code	Product Description	Product Information
HC-VMUX	4ch Analogue Input Multiplexer	Multiplexes four 0-10V analogue signals on to two analogue lines. this doubles the number of analogue inputs available. 24VAC/DC powered.

ANALOGUE DE-MULTIPLEXER

Product Code	Product Description	Product Information
HC-VDEMUX	4 Ch Analogue Demultiplexer	Demultiplexes one switched 0-10V analogue input to four analogue outputs. This requires two analogue lines one for the switched 0-10V and one for the output selection, this doubles the number of analogue outputs available. 24VAC/DC powered.

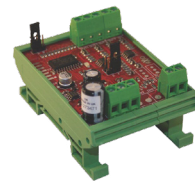

TRANSFORMERS

Product Code	Product Information
HC-TXD 6VA	HC-TXD range - 230V - 24VAC din rail transformers. Various VA ratings. Listed below transformers fitted with fuses on both the input and the output.
HC-TXD 25VA	HC-TXD range - 230V - 24VAC din rail transformers. Various VA ratings. Listed below transformers fitted with fuses on both the input and the output.
HC-TXD 30VA	HC-TXD range - 230V - 24VAC din rail transformers. Various VA ratings. Listed below transformers fitted with fuses on both the input and the output.
HC-TXD 60VA	HC-TXD range - 230V - 24VAC din rail transformers. Various VA ratings. Listed below transformers fitted with fuses on both the input and the output.

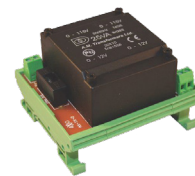

Product Code	Product Information
HC-SEM62.1	SEM62 range - 230V - 24VAC power supply din rail module. LED indication on secondary power supply. Integral self re-setting primary fuse, secondary power supply.
HC-SEM62.2	SEM62 range - 230V - 24VAC power supply din rail module. LED indication on secondary power supply. Integral self re-setting primary fuse, secondary power supply.



RAISE LOWER CONTROL MODULE

Product Code	Product Information
HC-ARL	Raise lower control module. Converts a 0-10V input signal into a raise lower relay output pair. 24VAC/DC powered.

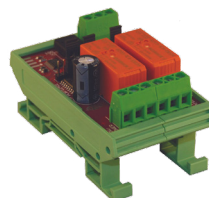

PHASE CUT MODULE

Product Code	Product Information
HC-PCM1-120I	120VA phase-cut output Din Rail module. To convert a 0-10V input signal to drive a 0-20V phase cut output.

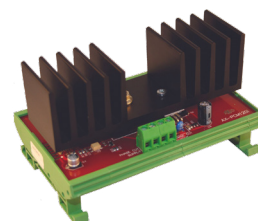

PHASE CUT MODULE

Product Code	Product Information
HC-PCM2-30I	Dual 30VA phase-cut output Din Rail module. To convert 1 or 2 0-10VDC contact input signals to 1 or 2, 0-20V phasecut outputs.



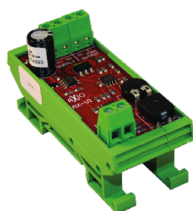
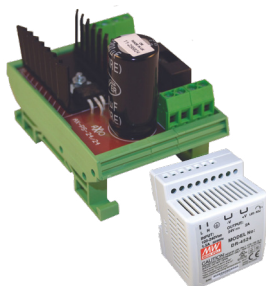
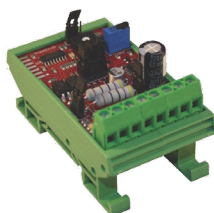
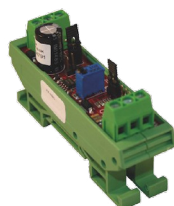
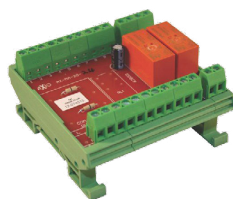

ALARM INTEGRATOR

Product Code	Product Information
HC-MA10-24	Alarm integration modules 240V or 24VAC/DC available in both 10 channel and 20 channel versions. Units provide a relay output in the event of an alarm signal appearing on any one or more inputs.
HC-MA10-230	
HC-MA20-24	
HC-MA20-230	

ANALOGUE BUFFER & CONVERSION MODULE

Product Code	Product Information
HC-ABC	Analogue buffer conversion module, designed to convert and buffer an analogue input signal to a voltage output. 24VAC/DC powered.

RAISE/LOWER TO ANALOGUE MODULE

Product Code	Product Information
HC-RLA-AC	Isolated raise / lower to analogue convertor. Converts a raise-lower input signal into a 0-10V analogue output.

COMMISSIONING TOOL

Product Code	Product Information
HC-REF-V1	Provides 0-10VDC and 4-20MA outputs in a switch selectable range. The unit is powered by a 24V plug top PSU (included with the unit). The unit can be used to test actuators on bench top prior to installation.

TRANSFORMERS

Product Code	Product Information
HC-PS-DR-45-24	24VDC 1AMP power supply Din Rail module. 230V input - 24V DC out. LED power on indicator.
HC-PS-24-24-1-C (COMMON 0V)	24VAC to 24VDC 1AMP convertor. A low cost power supply providing a regulated 24V DC output from a 24V input - Common 0V.
HC-PS-24-24-1-F	24VAC to 24VDC 1AMP convertor. A low cost power supply providing a regulated 24VDC output from a 24V input - Floating 0V.

CONVERSION MODULE

Product Code	Product Information
HC-VI	Is designed to convert a 0-10VDC input signal to a 4-20MA current output. Unit is powered by a 24VAC/DC and can power a current loop signal.

CURRENT SPLITTER MODULE

Product Code	Product Description	Product Information
HC-CSM-2	ANALOGUE TO 2 X 4-20MA	Current splitter module designed to split an analogue input to 2 x 4-20MA current outputs. Powered by 24VAC/DC and can power a current loop signal.
HC-CSM-3	ANALOGUE TO 3 X 4-20MA	
HC-CSM-4	ANALOGUE TO 4 X 4-20MA	

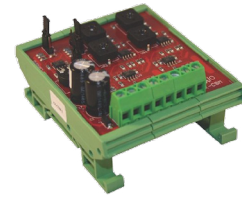

WINDOW ACTUATOR CONTROLLER

Product Code	Product Description	Product Information
HC-WAC	3 Channel window actuator controller with Lcd display	3 channel window controller providing timed forward/reverse outputs to open/close 2 wire DC window actuators.

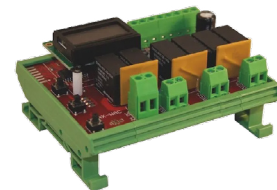

VOLTAGE RESCALING MODULE

Product Code	Product Information
HC-VSR	Voltage splitter and reference module takes 1 x 0-10VDC and splits and buffers the signal to give 3 x 0-10V outputs. The module also includes an adjustable reference output, factory set to 10V.

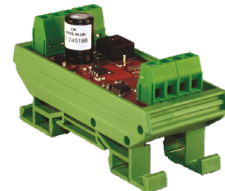

SINGLE PHASE FAN SPEED CONTROLLER

Product Code	Product Information
HC-FC-8	New compact single phase fan speed controller. 8AMP rated 230V powered for regulation of single phase AC motors.

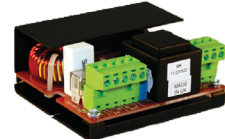

KYLAND ETHERNET SWITCHES

Product Code	Number of Ports	Product Information
OPAL5-E-5T-LV-LV	5	<ul style="list-style-type: none"> • 5, 8 & 16 port RJ45 fast Ethernet switches • Unmanaged (plug & play) • Supply voltage 18-30VAC/12-48VDC • IP30 aluminium DIN rail mount housing • Dual LED power supply indication & full LED link/ACT indication • Operating temperature -10°C to +60°C
OPAL8-E-8T-LV-LV	8	
OPAL20-E-16T-LV-LV	16	



Speak with our team
about any large projects



Order before 2pm for
same day dispatch



RELAYS & BASES

Product Code	Voltage	No. of Poles	Product Information
RM1-0001-12DS-S*	12VDC	1	RM1 Series - Relay C/W Base
RM1-000T-24A	24V	1	RM1 Series - Relay C/W Base
RM1-000T-24D	24VDC	1	RM1 Series - Relay C/W Base
RM1-000T-230A	230V	1	RM1 Series - Relay C/W Base

Product Code	Voltage	No. of Poles	Product Information
RM2-0001-12DC	12VDC	2	RM2 Series - Relay C/W Base
RM2-000T-24A	24V	2	RM2 Series - Relay C/W Base
RM2-000T-24D	24VDC	2	RM2 Series - Relay C/W Base
RM2-000T-230A	230V	2	RM2 Series - Relay C/W Base

*SAME AS SRM HIGH IMPEDANCE VERSION

RM1 & RM2 SERIES - ACCESSORIES

Product Code	Product Information
M61G	GREEN LED, 6-24VAC/DC
M63G	GREEN LED, 110V-240VAC
ZG-GZ80	8 WAY CONNECTOR BAR

RM1 & RM2 SERIES - ACCESSORIES

LED mechanical indicator and lockable front test button as standard.

Product Code	Voltage	No. of Poles
R2N 12VDC	12VDC	2
R2N-24VAC	24V	2
R2N-24VDC	24VDC	2
R2N-230VAC	230V	2

Product Code	Voltage	No. of Poles
R3N-12VDC	12VDC	3
R3N-24VAC	24V	3
R3N-24VDC	24VDC	3
R3N-230VAC	230V	3

Product Code	Voltage	No. of Poles
R4N-12VDC	12VDC	4
R4N-24VAC	24V	4
R4N-24VDC	24VDC	4
R4N-230VAC	230V	4

GZT & GZM SERIES - BASES

Product Code	To Suit Relay Type	Terminal Connection
GZT2	R2N	Top & Bottom
GZT3	R3N	Top & Bottom
GZT4	R4N	Top & Bottom
GZM3	R3N	Top
GZM4	R4N	Top

R2N, R3N & R4N SERIES - ACCESSORIES

Product Code	Product Information
ZG-GZ4	6 Way Connector Bar

L.E.D. PANEL INDICATOR LAMPS AD22 / AD16

Product Code	Voltage (V)	Product Information
AD22-R (RED)	24 or 240	FEATURES <ul style="list-style-type: none"> • Expected life span 30,000hrs • Intensity 60cd/m² • Rated current 20MA • Insulating resistance 2m • Voltage tolerance +/- 20% • Operating temperature - 25°C +55°C • Vibration frequency 2.8HZ acc 0.7g • IP rating IP65 • CE marked • LED type illumination
AD22-A (AMBER)	24 or 240	
AD22-G (GREEN)	24 or 240	
AD22-B (BLUE)	24 or 240	
AD22-W (WHITE)	24 or 240	
AD16-R (RED)	24 or 240	
AD16-A (AMBER)	24 or 240	
AD16-G (GREEN)	24 or 240	
AD16-B (BLUE)	24 or 240	
AD16-W (WHITE)	24 or 240	

LAMP TEST VERSION

Product Code	Voltage (V)	Product Information
AD22-R-LT (RED)	24 or 240	NOTE: Lamp Test Wiring T = Testing Terminal, S = Signal Terminal, C = Current Terminal (power in-put line)
AD22-A-LT A (MBER)	24 or 240	
AD22-G-LT (GREEN)	24 or 240	
AD22-B-LT (BLUE)	24 or 240	
AD22-W-LT (WHITE)	24 or 240	

AD22 FIXING TOOL

Product Code	Product Information
AD22 FIXING TOOL	A fixing tool to help with the mounting of the AD22 series panel lamps. The Tools engages with the locking collar to secure the AD22 panel lamps to a control panel. A must for any panel builders and service engineers.

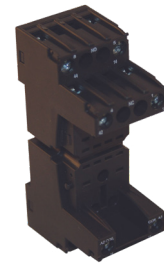



2/3 POSITION SELECTOR SWITCHES AND PUSH BUTTONS

Can accept either a voltage or current input which can be rescaled to either voltage or current output and also can reverse an input signal.

Product Code	Product Information
PB22SS2B-1A	2 Pos Selector Switch C/W 1 N/O Contact
PB22SS4B-1AA	3 Pos Selector Switch C/W 2 N/O Contact
PB22BFB-1A	Black Pushbutton C/W 1x N/O Contact
PB22BFG-1A	Green Pushbutton C/W 1x N/O Contact
PB22BFR-1B	Red Pushbutton C/W 1x N/C Contact

Accessories

PB22-A	Normally Open Contact Block
PB22-B	Normally Closed Contact Block

EMERGENCY ISOLATOR - IP65 RATED

Plastic enclosed Isolators LB Series 4 Pole up to 80 AMPS.



Product Code	Size (AMPS)
LB204P	20
LB324P	32
LB404P	40
LB634P	63
LB804P	80

RAC18-IP

TP-C-DISP-B

iSMACONTROLLI

Comfort Management Solution

WATER LEAK DETECTION MODULES

The AX-WLD2 is a range of single and dual zone water detection modules designed for Din Rail mounting. The water leak module can have a total of 200m of cable connected to each input (cable and header). A relay output provides an alarm signal to a remote alarm annunciator or a BMS system. The sensitivity is adjustable to ensure false returns are not given. An optional alarm buzzer can be incorporated.

Product Code	Product Information	FEATURES
AX-WLD2-24	24vac/Dc Alarm One Or Two Zone Detection Module	<ul style="list-style-type: none"> • A total of 200m cable on each zone • Adjustable sensitivity on each zone • Can take inputs from a mixture of cable sensors, rain sensors or point sensors • Audible alarm option • LED indication of each channel alarm • Normally open and closed contacts • Relay output to BMS or Alarm annunciator.
AX-WLD2-230	230v Alarm One Or Two Zone Detection Module	
AX-WLD2-24-A	24vac/Dc Alarm One Or Two Zone Detection Module & Alarm Buzzer	
AX-WLD2-230-A	230v Alarm One Or Two Zone Detection Module & Alarm Buzzer	
AX-WCS-5	Cable Sensor For Wld, 5m Cable 3m Header	
AX-WCS-10	Cable Sensor For Wld, 10m Cable 3m Header	
AX-WCS-15	Cable Sensor For Wld, 15m Cable 3m Header	
AX-WCS-20	Cable Sensor For Wld, 20m Cable 3m Header	
AX-WCS-xx	Customer Specified Cable And Header Length	
AX-WPS	Point Sensor For Wld	
AX-WRS1	Rain Sensor With 1m Cable For Wld	
AX-WLD-DTA	Single Zone Drip Tray Version	
AX-WLD	Enclosure For Ax-Wld2	

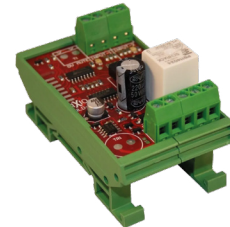

WATER LEAK DETECTION MODULE FOUR ZONE

The AX-WLDF Four zone water leak detection module with open or short circuit cable sensor detection. Must be used with "F" type sensors only (see below)

- LED indication of each alarm zone

Product Code	Product Information
AX-WLDF-24	Four Zone Module 24v
AX-WLDF-230	Four Zone Module 230v
AX-WLDF-C2	Cable Sensor For Wldf 2m Cable 1m Header
AX-WLDF-C5	Cable Sensor For Wldf 5m Cable 3m Header
AX-WLDF-C10	Cable Sensor For Wldf 10m Cable 3m Header
AX-WLDF-C15	Cable Sensor For Wldf 15m Cable 3m Header
AX-WLDF-C20	Cable Sensor For Wldf 20m Cable 3m Header
AX-WLDF-CXX	Cable Sensor For Wldf - Specify - Up To 200m
AX-WLDF-P2	Point Sensor Premium For Wldf & 2m Cable
AX-WLDF-P5	Point Sensor Premium For Wldf & 5m Cable



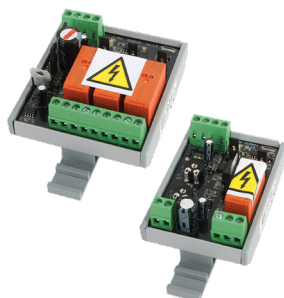
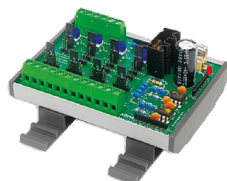
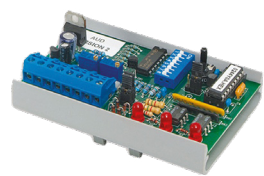
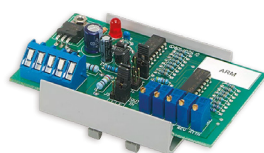

SONTAY IO MODULES

Sontay IO modules offer capability for rescaling, converting, isolating and overriding signals from BMS controllers.

ANALOGUE RESCALING MODULE

Can accept either a voltage or current input which can be rescaled to either voltage or current output and also can reverse an input signal.

Product Code	Product Information
IO-A-RM	Analogue Rescaling Module

RAISE/LOWER TO ANALOGUE MODULE

Accepts a Raise/Lower relay (pulsed relay contact inputs or pulsed DC or AC voltage inputs) signal and provides 0-10Vdc output

Product Code	Product Information
IO-A-UD	Raise/Lower to Analogue Module 45, 60, 120 or 240 seconds selectable.

ANALOGUE OVERRIDE MODULE

Intended for applications which require independent manual override of analogue output channels from a BMS controller, as a failsafe in event of controller failure.

Product Code	Product Information
IO-ABM4	4 Channel Override Module

DIGITAL INPUT MULTIPLEXERS

These Modules are to expand a BMS controllers input capacity by multiplexing four or six digital signals, or 24Vac/dc inputs into a single analogue controller unit.

Product Code	Product Information
IO-DIM-4	4 x VFC or 24V inputs to 1-10Vdc /4-20mA output
IO-DIM-6	6 x VFC or 24V inputs to 1-10Vdc /4-20mA output

RELAY MODULES

For use with BMS Controllers to convert an analogue control output to various switching relay modes.

Product Code	Product Information
IO-RM-2	2-stage Relay Module
IO-RM-3	3-stage Relay Module
IO-RM-4	4-stage Relay Module
IO-RM-8	8-stage Relay Module
IO-RM-A	The IO-RM-A adjustable relay module provides individually adjustable on and off switching points.

SINGLE RELAY MODULES

For use with BMS controllers for switching plant and isolation of input signals. Supplied complete with DIN-rail mounting base and retaining clip.

Product Code	Product Information
IO-RM1-12DC	Single Relay, 12Vdc Module
IO-RM1-24DC	Single Relay, 24Vdc Module
IO-RM1-24AC	Single Relay, 24Vac Module
IO-RM1-240AC	Single Relay, 240Vac Module

SONTAY SMART REMOTE IO MODULES

Sontays new range of mini Smart IO Modules offer extension to any BACnet or Modbus network when you require additional inputs & outputs. They allow easy integration of non-intelligent inputs and outputs to BACnet or Modbus network protocols.

Product Code	Product Information
SC-IO-100	Smart Communication IO Module 8U/I
SC-IO-102	Smart Communication IO Module 4 U/I, 2 U/O, & 2 B/O



SC-IO-100 · SC-IO-102

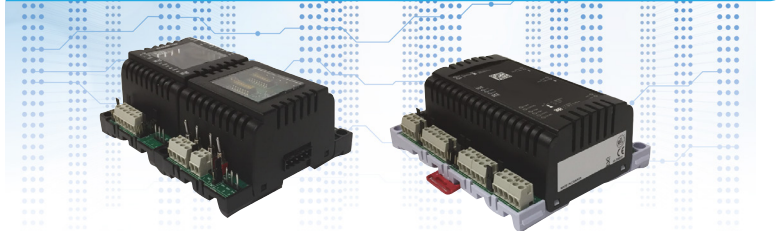

Provide simple expansion in any BMS application

Smart IO modules offer expansion with any BMS controller with BACnet or Modbus functionality

Options for your amount of inputs and outputs

Simple setup and Cost effective networkable device points via BACnet or Modbus

COMMUNICATION:

Selectable BACnet or Modbus communication

MAC address set via DIP switch or network

Copy & broadcast configuration to other SC-IO-10x modules (BACnet only)

FEATURES:

SC-IO-100:
8 Universal Inputs

SC-IO-102:
4 Universal Inputs -
2 Binary Outputs -
2 Analogue Outputs

Manual output override switches on SC-IO-102

DIN-rail mounting

LED status for power & inputs/ outputs

Smart Remote IO Modules

Bringing flexibility and functionality to your projects.

The SC-IO-10x products offer an extension to your BACnet or Modbus network. When your application requires additional inputs and outputs on a physical controller, you can combine I/O of the SC-IO-10x with your system, to provide simple expansion of a new or existing controller. Allowing easy integration on non-intelligent inputs and outputs. On-board LEDs help track and diagnose any input and output activity during operation.

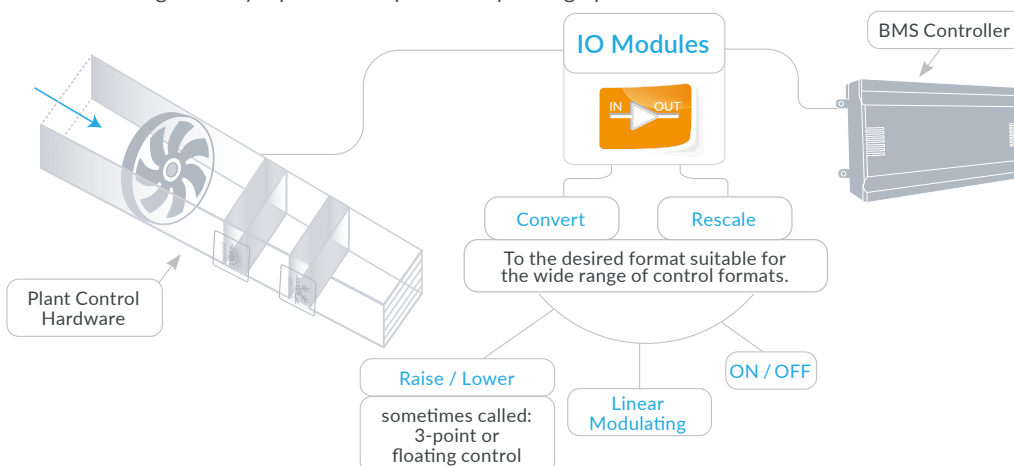

03

VALVES & ACTUATORS

Contents

Valves & Actuators

Johnson Controls	31
iSMA Controlli	41
Siemens	46
Goldseal	47
Danfoss	48
Industrie Technik	50
ESBE	51
Sauter	52
Vexve	54
Sontay	54
Xurox	54
Johnson / Joventa Damper Actuators	55
Belimo Actuators	57



Click the page number to
Navigate to the relevant page

JOHNSON CONTROLS

VG1000 SERIES BALL VALVES

The VG1000 series ball valves are used for the water control of air treatment systems in ventilation and air conditioning units as well as heating systems. They are operated by direct or remote mounted Spring Return and Non-Spring Return actuators by Johnson Controls.

Part Number	Description
VG1205AN	2 Port, DN15, 10 Kvs, PN40
VG1205BN	2 Port, DN20, 10 Kvs, PN40
VG1205CP	2 Port, DN25, 16 Kvs, PN40
VG1205DR	2 Port, DN32, 25 Kvs, PN40
VG1205ES	2 Port, DN40, 40 Kvs, PN40
VG1805AN	3 Port, DN15, 10 Kvs, PN40
VG1805BN	3 Port, DN20, 10 Kvs, PN40
VG1805CP	3 Port, DN25, 16 Kvs, PN40
VG1805DR	3 Port, DN32, 25 Kvs, PN40
VG1805ES	3 Port, DN40, 40 Kvs, PN40

For use with Johnson Controls Proportional and/or Floating & ON/OFF Actuators: M9108- VA9104-VA9203- VA9208-

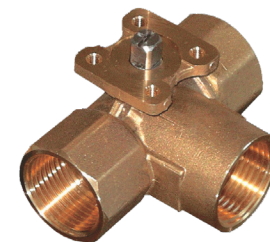
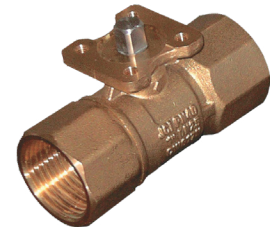

Dimensions (in mm)

Body Size	A	B	C	D	E
DN15	17	31	67	9	33
DN20	17	31	75	9	38
DN25	19	33	92	9	46
DN32	26	44	109	9	54
DN40	29	48	119	9	59
DN50	37	53	139	9	7

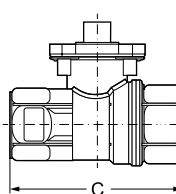
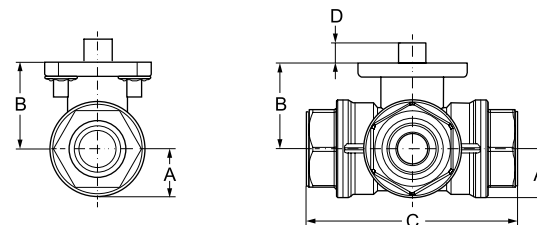

Two-way Valve

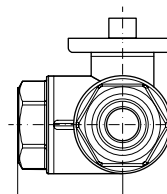
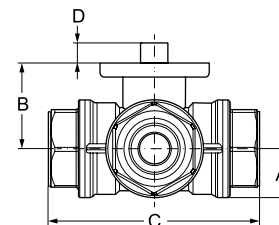

Three-way Valve



Speak with our team about any large projects



Order before 2pm for same day dispatch

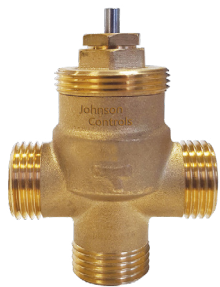
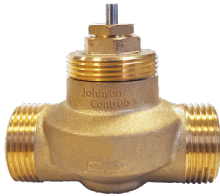

VG3000 SERIES TERMINAL UNIT VALVES

The VG3000 brass valve series is primarily designed to regulate the flow of water in response to the demand of a controller in zone and terminal unit applications and features: 2-way PDTC (NO) with 6 bar close off pressure; Extend range of KVS (0.4...6.3); Forged brass body, stainless steel stem, and spring; Actuator can be field installed after piping; And commissioning cap available as accessory (VG3000-CAP)

Part Number	Description			
Threaded Male Connection BSPP				
VG3210ES	2 - way PDTC	DN15	250 KPa	1.6 Kvs
VG3210FS	2 - way PDTC	DN15	250 KPa	2.5 Kvs
VG3210JS	2 - way PDTC	DN20	200 KPa	2.5 Kvs
VG3210KS	2 - way PDTC	DN20	200 KPa	4 Kvs
VG3210LS	2 - way PDTC	DN25	100 KPa	6.3 Kvs
VG3211FS	2 - way PDTC	DN15	600 KPa	2.5 Kvs
VG3211JS	2 - way PDTC	DN20	600 KPa	2.5 Kvs
VG3211KS	2 - way PDTC	DN20	600 KPa	4 Kvs
VG3211LS	2 - way PDTC	DN25	600 KPa	6.3 Kvs
VG3310FS	3 - way Mixing	DN15	250 KPa	2.5 Kvs
VG3310JS	3 - way Mixing	DN20	200 KPa	2.5 Kvs
VG3310KS	3 - way Mixing	DN20	200 KPa	4 Kvs
VG3310LS	3 - way Mixing	DN25	100 KPa	6.3 Kvs
VG3410ES	3 - way by-pass Mixing	DN15	250 Kpa	1.6 Kvs
VG3410FS	3 - way by-pass Mixing	DN15	250 Kpa	2.5 Kvs
VG3410JS	3 - way by-pass Mixing	DN20	250 Kpa	2.5 Kvs
VG3410KS	3 - way by-pass Mixing	DN20	250 KPa	4 Kvs
VG3410LS	3 - way by-pass Mixing	DN25	100 KPa	6.3 Kvs

* Other Kvs available

The valves are available in 2-way, 3-way mixing and 3-way mixing with built-in by-pass configurations

Also available in the following fittings

- Threaded Female Connection BSPP
- Threaded Female Connection NPT
- 1/2" Compression Valves

The following actuators are available for use with VG3000 Valves:

- VA-708x thermal ON/OFF actuator
- VA-709x thermal 0...10 V actuator
- VA-748x electric terminal unit valve actuator

VA708X AND VA709X ACTUATORS

The VA-708x Terminal Unit Actuators Series provide ON/OFF and DAT control, while the VA-709x provides Proportional Control in HVAC applications.

The compact design of these actuators make them suitable for installations in confined spaces, such as fan-coil applications.

Both VA-708x and VA-709x actuators are designed for field mounting onto VG3000 terminal unit valve, and VP1000 pressure independent valves.

Moreover, thanks to an innovative fixing system, the VA-708x is suitable for almost all the terminal unit valves in the market.

VA-708X

Part Number	Description	
VA-7088-21	24 V AC/DC +20% - 10%	ON/OFF
VA-7087-21	24 V AC/DC +20% - 10%	ON/OFF
VA-7081-21	24 V AC/DC +20% - 10%	ON/OFF
VA-7080-21	24 V AC/DC +20% - 10%	ON/OFF
VA-7088-23	230 V AC \pm 10%	ON/OFF
VA-7087-23	230 V AC \pm 10%	ON/OFF
VA-7081-23	230 V AC \pm 10%	ON/OFF
VA-7080-23	230 V AC \pm 10%	ON/OFF
VA-7088-21C	24 V AC/DC +20% - 10%	ON/OFF
VA-7088-23C	230 V AC \pm 10%	ON/OFF

VA-709X

Part Number	Description			
VA-7097-21	24 VAC	125 N	4.5mm Stroke	Normally open
VA-7098-21	24 VAC	125 N	4.5mm Stroke	Normally closed

VA-748X ACTUATOR

The VA-748x Series provides Floating, Proportional, or Proportional control with 0-10 V position feedback signal, offering a complete portfolio of actuators designed to be field mounted onto terminal unit valves from Johnson Controls or any other brand... thanks to the innovative concept of auto stroke detection, a VA-7480 can be installed over any conventional terminal unit valve or any PICV with variable strokes.

Part Number	Description		
VA-7480-0011	Floating	24 VAC	120 N
VA-7480-0311	Floating	24 VAC	120 N
VA-7481-0011	Floating	24 VAC	120 N
VA-7480-0001	Floating	24 VAC	120 N
VA-7481-0001	Floating	24 VAC	120 N
VA-7480-0201-TA	Floating	24 VAC	140 N
VA-7480-0501-TA	Floating	24 VAC	140 N



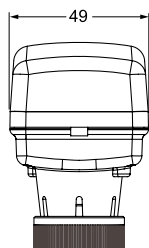
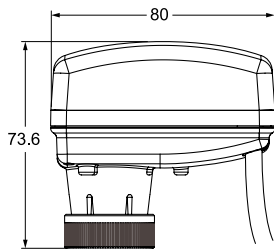

VA-748X ACTUATOR

Part Number	Description		
VA-7480-4001	Floating	24 VAC	120 N
VA-7480-4003	Floating	230 VAC	120 N
VA-7480-0013	Floating	230 VAC	120 N
VA-7481-0013	Floating	230 VAC	120 N
VA-7480-0003	Floating	230 VAC	120 N
VA-7481-0003	Floating	230 VAC	120 N
VA-7481-4003	Floating	230 VAC	120 N
VA-7482-1001	Proportional	24 VAC/VDC	120 N
VA-7482-2001	Proportional	24 VAC/VDC	120 N
VA-7482-3001	Proportional	24 VAC/VDC	120 N
VA-7482-1001-RA	Proportional	24 VAC/VDC	120 N
VA-7482-1301-RA	Proportional	24 VAC/VDC	120 N
VA-7482-2001-RA	Proportional	24 VAC/VDC	120 N
VA-7482-0011	Proportional	24 VAC/VDC	120 N
VA-7482-0311	Proportional	24 VAC/VDC	120 N
VA-7482-0312	Proportional	24 VAC/VDC	120 N
VA-7482-2201-TA	Proportional	24 VAC/VDC	140 N
VA-7482-2501-TA	Proportional	24 VAC/VDC	140 N
VA-7482-5001	Proportional	24 VAC/VDC	120 N
VA-7482-6001	Proportional	24 VAC/VDC	120 N
VA-7482-7001	Proportional	24 VAC/VDC	120 N
VA-7482-8201	Proportional	24 VAC/VDC	160 N
VA-7482-9201	Proportional	24 VAC/VDC	160 N
VA-7482-8201-RA	Proportional	24 VAC/VDC	160 N
VA-7482-9201-RA	Proportional	24 VAC/VDC	160 N
VA-7482-8002-RA	Proportional	24 VAC/VDC	160 N
VA-7482-9002-RA	Proportional	24 VAC/VDC	160 N
VA-7483-8201	Proportional	24 VAC/VDC	160 N
VA-7483-9201	Proportional	24 VAC/VDC	160 N
VA-7483-8201-RA	Proportional	24 VAC/VDC	160 N
VA-7483-9201-RA	Proportional	24 VAC/VDC	160 N
VA-7484-8001*	Proportional	24 VAC/VDC	160 N
VA-7484-9001*	Proportional	24 VAC/VDC	160 N
VA-7484-8001-RA*	Proportional	24 VAC/VDC	160 N
VA-7484-9001-RA*	Proportional	24 VAC/VDC	160 N

VG 7000 SERIES PLANT VALVES

VG7000 Series Bronze Control Valves are primarily designed to regulate the flow of water and steam in response to the demand of a controller in Heating, Ventilating, and Air Conditioning (HVAC) systems.

These valves are available in Push-Down-To-Close (PDTC), Push-Down-To-Open (PDTO), and 3-way mixing configurations. Both electric and pneumatic actuators are available for factory or field mounting.

Part Number	Description		
2-way PDTC (Normally Open) - Female Thread			
VG7201ET	DN15	8mm Stroke	1.6 Kvs
VG7201LT	DN20	8mm Stroke	6.3 Kvs
VG7201NT	DN25	13mm Stroke	10 Kvs
VG7201PT	DN32	13mm Stroke	16 Kvs
VG7201RT	DN40	19mm Stroke	25 Kvs
VG7201ST	DN50	19mm Stroke	40 Kvs

* Other Kvs available on request

* Stainless steel trim valves available (substitute 3 for 1 in the part number)

Part Number	Description		
3-WAY Mixing Configuration - Female Thread			
VG7802GT	DN15	8mm Stroke	4.0 Kvs
VG7802LT	DN20	8mm Stroke	6.3 Kvs
VG7802NT	DN25	13mm Stroke	10 Kvs
VG7802PT	DN32	13mm Stroke	16 Kvs
VG7802RT	DN40	19mm Stroke	25 Kvs
VG7802ST	DN50	19mm Stroke	40 Kvs

* Other Kvs available on request

* Stainless steel trim valves available (substitute 4 for 2 in the part number)

Following actuators are available for use with VG7000 Valves:

VA-77xx, VA-78xx

VG8000N SERIES PLANT VALVES

The VG8000 series electrically and pneumatically operated nodular iron valves are designed primarily to regulate the flow of water and steam in response to the demand of a controller, in HVAC systems. These valves are available in two-way, three way mixing and diverting configurations. Both electric and pneumatic actuators are available. PN16 rated nodular cast iron body - Large ranges of valves - Fluid temperature 0-180

Part Number	Description			
2-way PDTC (Normally Open)				
VG82F1S1N	DN50	25mm Stroke	PN16	40 Kvs
VG82G1S1N	DN65	25mm Stroke	PN16	63 Kvs
VG82H1S1N	DN80	25mm Stroke	PN16	100 Kvs
VG82J1S1N	DN100	42mm Stroke	PN16	160 Kvs
VG82K1S1N	DN125	42mm Stroke	PN16	250 Kvs
VG82L1S1N	DN150	42mm Stroke	PN16	350 Kvs

*Also available: NC valves (change 2 to 4 in the ordering code). DN15 -40 with Kvs values 0.63 -25.

Johnson
Controls

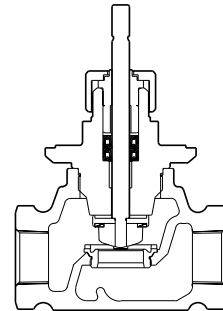

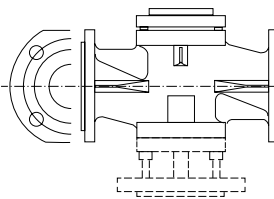
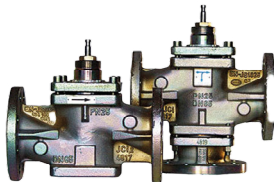
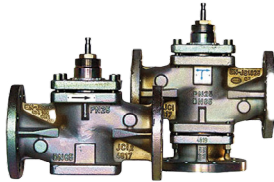

Part Number	Description	
3-way Mixing Configuration		
VG88F1S1N	DN50 25mm Stroke PN16	40 Kvs
VG88G1S1N	DN65 25mm Stroke PN16	63 Kvs
VG88H1S1N	DN80 25mm Stroke PN16	100 Kvs
VG88J1S1N	DN100 42mm Stroke PN16	160 Kvs
VG88K1S1N	DN125 42mm Stroke	250 Kvs
VG88L1S1N	DN150 42mm Stroke	350 Kvs

Part Number	Description	
3-way Diverting Configuration		
VG89F1S1N	DN50 25mm Stroke PN16	40 Kvs
VG89G1S1N	DN65 25mm Stroke PN16	63 Kvs
VG89H1S1N	DN80 25mm Stroke PN16	100 Kvs
VG89J1S1N	DN100 42mm Stroke PN16	160 Kvs
VG89K1S1N	DN125 42mm Stroke PN16	250 Kvs
VG89L1S1N	DN150 42mm Stroke PN16	350 Kvs

*Glycerine Cup Packing valves are available by adding suffix "20" to the ordering code

Following actuators are available for use with VG8000N Valves:
VA7800, VA1125

VG9000 DN15...100, PN6 AND PN10

These flanged valves are primarily designed to regulate the flow of water and low pressure steam in response to the demand of a controller, in Heating, Ventilating and Air Conditioning (HVAC) systems.

Part Number	Description		
VG94F1S1K	DN50	40 Kvs	2-way PDTO (Normally Closed) configuration
VG94G1S1K	DN65	63 Kvs	2-way PDTO (Normally Closed) configuration
VG94H1S1K	DN80	100 Kvs	2-way PDTO (Normally Closed) configuration
VG94J1S1K	DN100	160 Kvs	2-way PDTO (Normally Closed) configuration

Part Number	Description		
VG98F1S1K	DN50	40 Kvs	3-way mixing configuration
VG98G1S1K	DN65	63 Kvs	3-way mixing configuration
VG98H1S1K	DN80	100 Kvs	3-way mixing configuration
VG98J1S1K	DN100	160 Kvs	3-way mixing configuration

Following electric actuators are available for use with VG9000 valves:

VA-7700 for DN15... DN50 valves

VA7810 for DN15... DN65 valves

VA1125 for DN65... DN100 valves

VA-7700 FLOATING AND PROPORTIONAL CONTROL

The VA-7700 series provides Floating and Proportional control and can be mounted onto VG7000, VGS800 and VG9000 valves.

MOUNTING ONTO VG7000 SERIES VALVES

Part Number	Description		
VA-7700-1001	24 VAC	500N	Floating
VA-7700-1003	230 VAC	500N	Floating
VA-7740-1001	24 VAC	500N	Floating
VA-7740-1003	230 VAC	500N	Floating
VA-7706-1001	24 VAC	500N	Proportional
VA-7746-1001	24 VAC	500N	Proportional

MOUNTING ONTO VGS800 AND VG9000 SERIES VALVES

Part Number	Description		
VA-7700-8201	24 VAC	500N	Floating
VA-7700-8203	230 VAC	500N	Floating
VA-7740-8201	24 VAC	500N	Floating
VA-7740-8203	230 VAC	500N	Floating
VA-7706-8201	24 VAC	500N	Proportional
VA-7746-8201	24 VAC	500N	Proportional

VA7810 NON-SPRING RETURN PLANT VALVE ACTUATORS

FLOATING AND PROPORTIONAL CONTROL

The VA7810 Non Spring Return Actuator with 1000 N thrust for valves in heating, ventilation and air conditioning applications is available for Floating or Proportional control. All models have manual override as standard and provide stroke capabilities of 7 mm to 25 mm. Proportional models are self-calibrating.

The actuator is intended for use with Johnson Controls VG7000 and VGS800 threaded valves as well as VG8000 and VG9000 flanged valves. All valves should be fitted in accordance with the maximum close-off pressure ratings specified. Valve/actuators can be ordered as separate units or as a factory fitted valve/actuator combinations.

MOUNTING ONTO VG7000 AND VGS800 THREADED VALVES

Part Number	Description		
VA7810-ADA-11	230 VAC	1000N	ON/OFF or Floating
VA7810-ADC-11	230 VAC	1000N	ON/OFF or Floating
VA7810-AGA-11	24 VAC	1000N	ON/OFF or Floating
VA7810-AGC-11	24 VAC	1000N	ON/OFF or Floating
VA7810-AGH-11	24 VAC	1000N	ON/OFF or Floating
VA7810-GGA-11	24 VAC	1000N	ON/OFF or Floating or Proportional
VA7810-GGC-11	24 VAC	1000N	ON/OFF or Floating or Proportional

Johnson
Controls

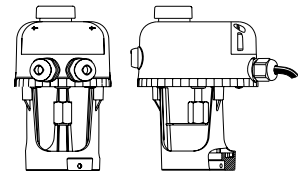



MOUNTING ONTO VG8000 AND VG9000 FLANGED VALVES

Part Number	Description		
VA7810-ADA-12	230 VAC	1000N	ON/OFF or Floating
VA7810-ADC-12	230 VAC	1000N	ON/OFF or Floating
VA7810-AGA-12	24 VAC	1000N	ON/OFF or Floating
VA7810-AGC-12	24 VAC	1000N	ON/OFF or Floating
VA7810-AGH-12	24 VAC	1000N	ON/OFF or Floating
VA7810-GGA-12	24 VAC	1000N	ON/OFF or Floating or Proportional
VA7810-GGC-12	24 VAC	1000N	ON/OFF or Floating or Proportional

VA1125 NON-SPRING RETURN PLANT VALVE ACTUATORS

The VA1125 Valve Actuators are used to control Valves in HVAC systems. They are of modular construction so that the required type of control signal is achieved simply by fitting a module with the required function in-situ. It can be mounted onto VG8000, VG8300 and VG9000 series valves.

Part Number	Description			
VA1125-GGA-1	24 VAC	2500N	Non-Spring Return	IP66



ACCESSORIES MODULES FOR ON SITE INSTALLATION

Part Number	Description
VA1000-M230N	230 VAC module
VA1000-P2	2 K Ω feedback potentiometer
VA1000-S2	2 SPDT auxiliary switches
VA1000-EP	Extension kit for applications with temperatures greater than 140 °C up to 200 °C

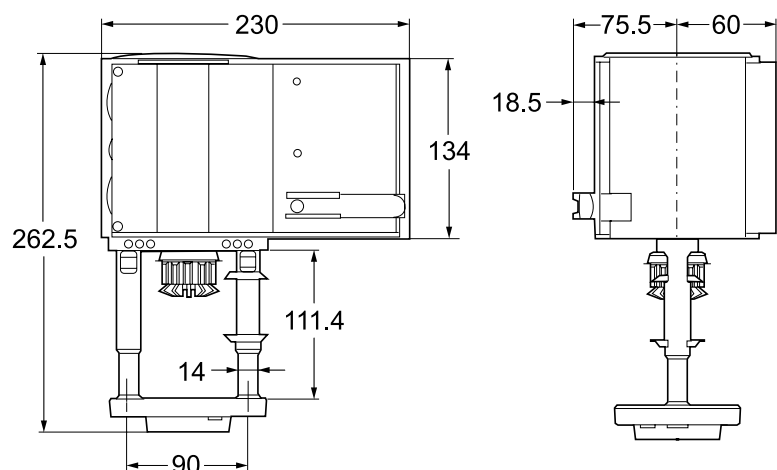

PRESSURE INDEPENDENT CONTROL VALVES

The VP1000 Pressure Independent Control Valve is a combination of a differential pressure regulator and a regulating valve for flow adjustment.

THE VP1000 Valve allows to adjust the flow rate also in case of partial load of the system and it always ensures a stable adjustment of the supply connected to it. The differential pressure regulator corrects any differential pressure variation. This leads to a considerable reduction in temperature variations and adjustment movements and to the extension of the life of the moving devices connected to it.

COMPACT & AXIAL VALVES

Part Number	Description		
VP100HAA	DN 15	150 l/h	Int screwed
VP100HDE	DN 15	600 l/h	Int screwed
VP100HDC	DN 15	780 l/h	Int screwed
VP100JAJ	DN 20	1000 l/h	Int screwed
VP100J	DN 20	1500 l/h	Int screwed
VP100CAU	DN 25	2200 l/h	Int screwed
VP100CAW	DN 25	2700 l/h	Int screwed
VP100DAW	DN 32	2700 l/h	Int screwed
VP100DAY	DN 32	3000 l/h	Int screwed

T90 - Also available with Pressure Port. (Change VP101 to VP100 in Part Number)

Following actuators are available:

VA-708x ON/OFF thermal

VA-709x thermal 0...10 VDC

VA-748x floating and proportional electric

BALL TYPE VALVES

Part Number	Description		
VP101DBB	DN 40	6001 l/h	Int screwed
VP101EBB	DN 40	6001 l/h	Int screwed
VP101EBD	DN 40	11001 l/h	Int screwed
VP101EBC	DN 50	12000 l/h	Int screwed
VP101FBD	DN 50	12000 l/h	Int screwed
VP101FBF	DN 50	12000 l/h	Int screwed
VP101GBF	DN 55	18000 l/h	Ext screwed

Following actuators are available:

M9108-

VA9310

VA9208

See Rotary/Damper Actuators





FLANGE TYPE VALVES

Part Number	Description	???	???
VPA050-C	DN 50	13000 l/h	Flanged
VPA065-C	DN 65	21000 l/h	Flanged
VPA080-C	DN 80	28000 l/h	Flanged
VPA100-C	DN 100	50000 l/h	Flanged
VPA125-C	DN 125	90000 l/h	Flanged
VPA150-C	DN 150	145000 l/h	Flanged

VAP1000-24-C AND VAP3000-24-C ACTUATORS

Actuators	Description	
VAP600S-24-C	24 Vac	600N
VAP1000S-24-C	24 Vac	1000N
VAP1000L-24-C	24 Vac	1000N
VAP3000-24-C	24 Vac	3000N

VFB BUTTERFLY VALVES

VFB butterfly valves series are specifically designed for a wide range of Heating, Ventilating, and Air Conditioning (HVAC) applications, including two-position and modulating control of hot, chilled, or condenser water, and 50/50 glycol solutions. All valves are factory tested for bubble-tight shutoff at 100% of the fully-rated pressure. These valves are also bidirectional, allowing positive shutoff with the flow in either direction, and can be used with M9000 actuators and the necessary linkage.

Actuators	Description		
VFB025H	DN 25	52 Kvs	1000 kPa
VFB032H	DN 32	72 Kvs	1000 kPa
VFB040H	DN 40	126 Kvs	1000 kPa
VFB050H	DN 50	124 Kvs	1200 kPa
VFB065H	DN 65	243 Kvs	1200 kPa
VFB080H	DN 80	397 Kvs	1200 kPa
VFB100H	DN 100	723 Kvs	1200 kPa
VFB125H	DN 125	1083 Kvs	1200 kPa
VFB150H	DN 150	1591 Kvs	1200 kPa
VFB200H	DN 200	2852 Kvs	1200 kPa
VFB250H	DN 250	4670 Kvs	1200 kPa
VFB300H	DN 300	6946 Kvs	1200 kPa
VFB350H	DN 350	9063 Kvs	1000 kPa

Low Pressure Close-off also available

iSMA CONTROLLI BALL VALVES

For use in heating, ventilation, heating systems, and air conditioning systems, pneumatic systems and irrigation. Thanks to the characterised plug, the modulating models fully fit the equal percentage characteristic. Available in 2 and 3 way threaded connections, both provided with on/off actuator MVS210 and MVS410. Brass body (EN-12165 CW617N), Seat PTFE and Chrome plated Brass ball (EN-12164 CW617N). Sealing leakage: Tight close-off. Connections: Female threaded (except VSD3 and VSD4)

Part Number	Description			
VSS2	2-way	On/Off	DN15	20 Kvs
VSS3	2-way	On/Off	DN20	45 Kvs
VSS4	2-way	On/Off	DN25	60 Kvs
VSS5	2-way	On/Off	DN32	100 Kvs
VSS6	2-way	On/Off	DN40	120 Kvs
VSS8	2-way	On/Off	DN50	220 Kvs
VSC2	2-way	Modulating	DN15	4 Kvs
VSC3	2-way	Modulating	DN20	6.3 Kvs
VSC4	2-way	Modulating	DN25	10 Kvs
VSC5	2-way	Modulating	DN32	16 Kvs
VSC6	2-way	Modulating	DN40	25 Kvs
VSC8	2-way	Modulating	DN50	40 Kvs
VSD3 (FFM)	3-way diverting	On/Off	DN20	9.6 Kvs
VSD4 (FFM)	3-way diverting	On/Off	DN25	11.3 Kvs
VSD5	3-way diverting	On/Off	DN32	19.2 Kvs
VSD6	3-way diverting	On/Off	DN40	27.7 Kvs
VSD8	3-way diverting	On/Off	DN50	57 Kvs
VDC2	3-way mixing	Modulating	DN15	4 Kvs
VDC3	3-way mixing	Modulating	DN20	6.3 Kvs
VDC4	3-way mixing	Modulating	DN25	10 Kvs
VDC5	3-way mixing	Modulating	DN32	16 Kvs
VDC6	3-way mixing	Modulating	DN40	25 Kvs
VDC8	3-way mixing	Modulating	DN50	40 Kvs

ACTUATORS

Part Number	Description			
MVS210	Rotary actuator	230V On/Off	10N	40 Sec
MVS410	Rotary actuator	24V On/Off	10N	40 Sec
MVS216	Rotary actuator	230V On/Off	16N	60 Sec
MVS416	Rotary actuator	24V On/Off	16N	60 Sec
MVS516	Rotary actuator	24V, Modulating, 0-10V	6N	60 Sec
MVSHT	Spacer for MVS_16 actuators			





2TBB & 3TBB GLOBE VALVES

The 2TBB and 3-way 3TBB two-way valves can be used for the control or interception of fluids in air conditioning, heating and heating systems, civil and industrial, in machines for the heat treatment of products and in systems for domestic hot water. The 3-way valves must be used exclusively as mixers. Never use the angled pathway for adjustment.

These valves are designed to be motorized by MVC and MVE actuators.

Part Number	Description		
2 way globe valves, Internal threaded, DN15 - DN50, PN16, bronze			
2TBB15	DN15	2.5 Kvs	9.5mm stroke
2TBB20	DN20	5 Kvs	9.5mm stroke
2TBB25	DN25	10 Kvs	15.9mm stroke
2TBB32	DN32	16 Kvs	15.9mm stroke
2TBB40	DN40	25 Kvs	15.9mm stroke
2TBB50	DN50	38 Kvs	15.9mm stroke
3 way globe valves, Internal threaded, DN15 - DN50, PN16, bronze			
3TBB15	DN15	2.5 Kvs	9.5mm stroke
3TBB20	DN15	10 Kvs	15.9mm stroke
3TBB25	DN15	10 Kvs	15.9mm stroke
3TBB32	DN15	16 Kvs	15.9mm stroke
3TBB40	DN15	25 Kvs	15.9mm stroke
3TBB50	DN15	38 Kvs	15.9mm stroke

2TBB.T COMPACT GLOBE VALVES

The 2TBB.T two-way valves 3TBB.T can be used for the control or interception of fluids in air conditioning, heating and heating systems, civil and industrial, in machines for the heat treatment of products and in water systems. hot sanitary. The 3-way valves must be used exclusively as mixers. Never use the angled corner for adjustment.

Can be driven with MVH and MVE actuators.



Part Number	Description				
2TBB15T	2 Port	12mm Stroke	PN16	DN15	Kvs 2.5*
2TBB20T	2 Port	12mm Stroke	PN16	DN20	Kvs 4*
2TBB25T	2 Port	12mm Stroke	PN16	DN25	Kvs 8*
2TBB32T	2 Port	12mm Stroke	PN16	DN25	Kvs 12*
2TBB40T	2 Port	12mm Stroke	PN16	DN32	Kvs 21*
2TBB50T	2 Port	12mm Stroke	PN16	DN40	Kvs 33*
3TBB15T	3 Port	12mm Stroke	PN16	DN15	Kvs 2*
3TBB20T	3 Port	12mm Stroke	PN16	DN20	Kvs 5*
3TBB25T	3 Port	12mm Stroke	PN16	DN25	Kvs 10*
3TBB32T	3 Port	12mm Stroke	PN16	DN32	Kvs 16*
3TBB40T	3 Port	12mm Stroke	PN16	DN40	Kvs 25*
3TBB50T	3 Port	12mm Stroke	PN16	DN40	Kvs 38*

2FGB & 3FGB FLANGED VALVES

The 2FGB.L series valves are used for the control of fluids belonging to the group, as per art. 13 of Directive 2014/68/EU (PED), in air conditioning systems, thermal ventilation of fluids and civil and industrial heating systems and thermal machines for industrial processes. They can not be used as safety valves.

The 2-3FGB.L series is designed with PTFE gaskets to offer a perfect seal both on the direct route and on the corner road.

These valves are designed to be motorized by MVH and MVE actuators.

Part Number	Description		
2 way globe valves, flanged, cast iron body			
2FGB65	DN65	63 Kvs	25 mm Stroke
2FGB80	DN80	100 Kvs	45 mm Stroke
2FGB100	DN100	130 Kvs	45 mm Stroke
2FGB125	DN125	200 Kvs	45 mm Stroke
2FGB150	DN150	300 Kvs	45 mm Stroke
2FGA200B	DN200	500 Kvs	45 mm Stroke
3 way globe valves, flanged, DN65 - DN200, PN16, cast iron body			
3FGB65	DN65	63 Kvs	25 mm Stroke
3FGB80	DN80	100 Kvs	45 mm Stroke
3FGB100	DN100	130 Kvs	45 mm Stroke
3FGB125	DN125	200 Kvs	45 mm Stroke
3FGB150	DN150	300 Kvs	45 mm Stroke

MVC COMPACT ACTUATOR

Part Number	Description	
MVC203	230Vac On/Off/Float	16mm Stroke, 80Secs, 300N
MVC403	24Vac On/Off/Float	16mm Stroke, 80Secs, 300N
MVC503	24Vac Proportional	16mm Stroke, 80Secs, 300N
MVC503R	24 Vac/dc Proportional Spring Return	12mm Stroke, 36 Secs, 300N
MVC503R-MB	24 Vac/dc Proportional Spring Return Modbus	12mm Stroke, 36 Secs, 300N

 iSMA CONTROLLI



Speak with our team
about any large projects



Order before 2pm for
same day dispatch

Contact our Rol sales team on +353 (0)1 457 5421 or email sales@ibc.ie

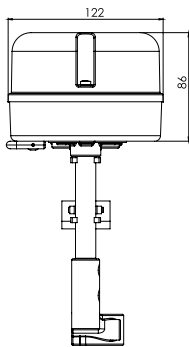
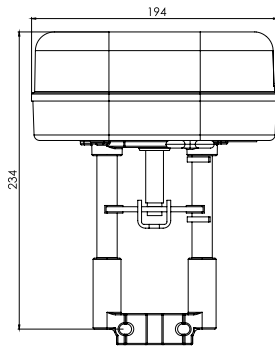

MVE ACTUATORS

MVE is a very flexible electromechanical actuator for the control of two and three-way globe valves usable in heating and air conditioning systems, air handling units; district heating plants; industrial control systems.

The actuator can be controlled either by a proportional (modulating) or by a floating signal. Installing and connecting the actuator is very simple. It is possible to mount it directly on all types of CONTROLLI flanged valves, while for the CONTROLLI threaded valves and for the valves of other manufacturers, connection kits are available.

The actuator has a very high resolution (500 steps over the entire stroke range) for precise control of the fluid temperature and is able to self-calibrate on different strokes without the need for user intervention (this function is selectable through the DIP switches present). MVE is equipped with diagnostic functions which, in the event of faults, indicate the specific problem by means of 2 LEDs (RED and GREEN) located on the control board.

Part Number	Description			
MVE504S	Modulating/Float	24V	60mm Stroke	400N
MVE504S-65	Modulating/Float IP65	24V	60mm Stroke	400N
MVE504SR	Modulating/Float Spring return	24V	60mm Stroke	400N
MVE504SR-65	Modulating/Float Spring return IP65	24V	60mm Stroke	400N
MVE506	Floating & Proportional	24V	60mm Stroke	600N
MVE510	Floating & Proportional	24V	60mm Stroke	1000N
MVE515	Modulating/Float	24V	60mm Stroke	1500N
MVE515-IP65	Modulating/Float IP65	24V	60mm Stroke	1500N
MVE515SR	Modulating/Float Spring return	24V	60mm Stroke	1500N
MVE515-IP65-SR	Modulating/Float Spring return IP65	24V	60mm Stroke	1500N
MVE522	Floating & Proportional	24V	60mm Stroke	2200N
MVE204S	Modulating/Float	230V	60mm Stroke	400N
MVE204S-65	Modulating/Float IP65	230V	60mm Stroke	400N
MVE204SR	Modulating/Float Spring return	230V	60mm Stroke	400N
MVE204SR-65	Modulating/Float Spring return IP65	230V	60mm Stroke	400N
MVE206	Floating & Proportional	230V	60mm Stroke	600N
MVE210	Floating & Proportional	230V	60mm Stroke	1000N
MVE215	Modulating/Float	230V	60mm Stroke	1500N
MVE215-IP65	Modulating/Float IP65	230V	60mm Stroke	1500N
MVE215-SR	Modulating/Float Spring return	230V	60mm Stroke	1500N
MVE215-IP65-SR	Modulating/Float Spring return IP65	230V	60mm Stroke	1500N

Ordering Information

MVE is the model
2 or 5 is the power supply...24v is 5, 230v is 2
04, 06, 10 etc is the force... 400Nm, 600Nm, etc
S is short yoke
R is with failsafe
IP65 is the part number for outdoor rating

PRESSURE INDEPENDENT CONTROL VALVES

LIBRA pressure independent control valves are suitable for a wide range of hydronic applications in the building services industry. Fan-coil units and chilled beams are probably the most familiar applications of pressure independent control valves with the move from 4-ports (or 3-ports) to 2-ports valves driven primarily by the need to reduce excessive energy consumption of pumps and thermal losses through pipework.

Pressure-independent control valves are exactly what the name suggests. They maintain a constant pre-set differential pressure across a control valve such that control action of the valve is not affected by inlet-pressure instability.

These valves can be motorized by a wide range of actuators including MCA, MVC, MVE and MVT types

Part Number	Description			
Threaded connections without P/T plugs				
VLX1	DN15	375 L/H Ext screwed	2 port, PN16	4mm stroke
VLX2	DN15	3/4" M connection 800 L/H Ext screwed	2 port, PN16	4mm stroke
VLX3	DN20	1" M connection 1000 L/H Ext screwed	2 port, PN16	4mm stroke
VLX4	DN25	1-1/4" M connection 2000 L/H Ext screwed	2 port, PN16	4mm stroke
VLX5	DN32	1-1/2" M connection 4000 L/H Ext screwed	2 port, PN16	4mm stroke
Threaded connections with P/T plugs				
VLX1P	DN15	375 L/H Ext screwed	2 port, PN16	4mm stroke
VLX2P	DN15	3/4" M connection 800 L/H Ext screwed	2 port, PN16	4mm stroke
VLX3P	DN20	1" M connection 1000 L/H Ext screwed	2 port, PN16	4mm stroke
VLX4P	DN25	1-1/4" M connection 2000 L/H Ext screwed	2 port, PN16	
VLX5P	DN32	1-1/2" M connection 4000 L/H Ext screwed	2 port, PN16	4mm stroke
VLX8P	DN50	2" F connection, 12500 L/H. Int screwed	2 port, PN16	15mm stroke



MCA ACTUATORS

Part Number	Description
MCA230L	230V AC, 140 N, 4mm Stroke
MCA230LM	230V AC, 140 N, 4mm Stroke, Auxiliary Microswitch
MCA24L	24 VAC/DC, 140 N, 4mm Stroke
MCA24LM	24 VAC/DC, 140 N, 4mm Stroke, Auxiliary Microswitch

MVT ACTUATORS

Part Number	Description		
MVT203	3-point - ON/ OFF	230 V AC	16 mm Stroke
MVT403	3-point - ON/ OFF	24 V AC	16 mm Stroke
MVT503	Proportional	24 V AC	16 mm Stroke
MVT203S	3-point - ON/ OFF	230 V AC	9 mm Stroke
MVT403S	3-point - ON/ OFF	24 V AC	9 mm Stroke
MVT503S	Proportional	24 V AC	9 mm Stroke

SIEMENS

SAS - ELECTROMOTIVE ACTUATORS FOR VALVES

Electromotive actuators with 5.5 mm stroke and 400 N positioning force used as control and shutoff valves in heating and ventilation plants.



Part Number	Operating voltage	Control Signal	Pos. Time
SAS31.00	AC 230 V	3-position	120 s
SAS31.03			30 s
SAS31.50			120 s
SAS31.53			30 s
SAS61.03	AC / DC24 V	DC 0...10 VDC 4...20 mA0...1000 Ω	30 s
SAS61.03U		Modbus RTU	
SAS61.03/MO			
SAS61.33		DC 0...10 VDC 4...20 mA0...1000 Ω	
SAS61.33U		Modbus RTU	
SAS61.33/MO			
SAS61.53	DC 0...10 VDC 4...20 mA0...1000 Ω		
SAS81.00	AC / DC24 V	3-position	120 s
SAS81.03			30 s
SAS81.03U			
SAS81.33			
SAS81.33U			

SAX..P - ELECTROMOTORIC ACTUATORS FOR VALVES

Actuators with 20 mm stroke and 500 N force. Electromotoric actuators to operate as control valves on ventilation, air conditioning, district heating and refrigeration plants.



Part Number	Operating voltage	Positioning signal
SAX31P03	AC 230 V	3-position
SAX61P03	AC 24 V DC 24 V	DC ...10 V DC 4...20 mA0...1000 Ω
SAX61P03/MO		Modbus RTU
SAX81P03		3-position

SSC - ELECTROMOTORIC ACTUATORS

For operation of water-side control of hot and cooling water in heating, ventilation and air conditioning systems.



Part Number	Operating voltage	Run time at 50 Hz	Control signal	Auxiliary switch
SSC31	AC 230 V	150 s	3-position	
SSC81	AC 24 V			
SSC61	AC / DC 24 V	30 s	DC 0...10 V	
SSC61.5				With fail-safe function (30 s)

SSB - ELECTROMOTORIC ACTUATORS

For operation of water-side control of hot and cooling water in heating, ventilation and air conditioning systems.

Part Number	Operating voltage	Run time at 50 Hz	Control signal	Auxiliary switch
SSB31	AC 230 V	150 s	3-position	
SSB31/00				
SSB31.1				Yes
SSB81	AC 24 V			
SSB81/00				
SSB81.1				Yes
SSB61	AC / DC 24 V	75 s	DC 0...10 V	
SSB61/00				

SIEMENS



WRAS APPROVED SOLENOID VALVES-GOLDSEAL

The WRAS approved range of 2 way normally closed servo assisted solenoid valves.

FEATURES

- WRAS approved solenoid valves for water
- EPDM seal, brass body
- For temperatures up to 120c
- Pressure range 0 -16 bar
- Normally closed as standard

Part Number	Size (inch)	Voltage
WSV-G-15/230	½"	230
WSV-G-20/230	¾"	230
WSV-G-25/230	1"	230
WSV-G-32/230	1¼"	230
WSV-G-40/230	1½"	230
WSV-G-50/230	2"	230

Part Number	Size (inch)	Voltage
WSV-G-15/24	½"	24
WSV-G-20/24	¾"	24
WSV-G-25/24	1"	24
WSV-G-32/24	1¼"	24
WSV-G-40/24	1½"	24
WSV-G-50/24	2"	24

Suffixes (add to part code)

A - 24VAC

D - 24 VDC

Part Number	Description	Voltage
WSV-G 24	Spare Coils	24
WSV-G 230	Spare Coils	230



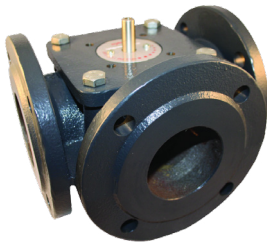

DANFOSS ROTARY SHOE VALVES

HFE rotary valves are primarily designed for regulation of flow temperature in heating systems where a certain leakage can be accepted and where a defined control characteristic is not required.

Rotary shoe valves for 20-150mm, used with 3-point and Modulating (0 - 10V) actuators - HFE flanged valves, PN6 cast iron body - Suitable for medium temperature up to 110°C - Lowest leakage in class - For mixing and diverting applications.

Part Number	Description			
065Z0418	HRE3 20/6.3	DN20	6.3 Kvs	3 - way mixing
065Z0419	HRE3 25/10	DN25	10 Kvs	3 - way mixing
065Z0420	HRE3 32/16	DN32	16 Kvs	3 - way mixing
065Z0421	HRE3 40/25	DN40	25 Kvs	3 - way mixing
065Z0422	HRE3 50/40	DN50	40 Kvs	3 - way mixing
065Z043300	HFE3 65/90	DN65	90 Kvs	3 - way mixing
065Z043400	HFE3 80/150	DN80	150 Kvs	3 - way mixing
065Z043500	HFE3 100/225	DN100	225 Kvs	3 - way mixing
065Z043600	HFE3 125/280	DN125	280 Kvs	3 - way mixing
065Z043700	HFE3 150/400	DN150	400 Kvs	3 - way mixing
ET3	Linkage for Shoe Valve			

DANFOSS ROTARY SHOE VALVE ACTUATORS

AMB actuators for use with HRE/HFE rotary shoe valves. For use in 3-point control and modulating applications with LED indication of turning direction, selectable speed on DIP switch and manual valve turning mode enabled by a permanent clutch.

Part Number	Description	
082H0213	AMB162 24V	HRE 20-50
082H0218	AMB162 24V	HRE 20-50, Auxiliary Switch
082H0234	AMB182 24V	HFE 65-150
082H0236	AMB182 24V	HFE 65-150, Auxiliary Switch
082H0223	AMB162 230V	HRE 20-50
082H0228	B162 230V	HRE 20-50, Auxiliary Switch
082H0238	AMB182 230V	HFE 65-150
082H0240	AMB182 230V	HFE 65-150, Auxiliary Switch
082H0230	AMB162 24 0-10V	HRE 20-50
082H0241	AMB182 24 0-10V	HFE 65-150



Speak with our team
about any large projects



Order before 2pm for
same day dispatch

DANFOSS AMZ 2 PORT MOTORISED BALL VALVES

The AMZ range of motorised ball valves are typically used in domestic and commercial central heating applications. Supplied as complete valve/actuator assembly with indication of actual valve position. Suitable for medium temperature up to 110°C with auxiliary switch fitted as standard with LED indication. Silent and reliable operation.

Part Number	Description	
082G5406	DN15	230V
082G5407	DN20	230V
082G5408	DN25	230V
082G5409	DN32	230V
082G5410	DN40	230V
082G5411	DN50	230V
082G5400	DN15	24V
082G5401	DN20	24V
082G5402	DN25	24V
082G5403	DN32	24V
082G5404	DN40	24V
082G5405	DN50	24V



DANFOSS AMZ 3 PORT MOTORISED BALL VALVES

Part Number	Description	
082G5418	DN15	230V
082G5419	DN20	230V
082G5420	DN25	230V
082G5421	DN32	230V
082G5412	DN15	24V
082G5413	DN20	24V
082G5414	DN25	24V
082G5415	DN32	24V



Speak with our expert
BMS engineers today



Online training available
please speak with our team



industrie
technik®

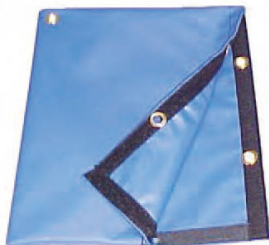

Industrie Technik DB-VZ2 & VZ3 ZONE VALVES

The valves DB-VZ coupled with the synchronous motor SM230/ CA, SM24/CA and SM230/SA, SM24/SA are suitable for heating and cooling water in zone systems for ON-OFF control. Typical applications are for fan-coil units.

Connection between actuator and valve by nut for a convenient mounting - Female threaded connections. - Power supply from electric system, synchronous motor with clutch.

- Actuator is fitted with manual operating lever for manual override when power supply is not applied or if a power failure occurs. - Silent operation. - Strong gear and spring for

long-term working. - Reliability. - Models are available with an optional end stroke switch to provide valve position indication or control function such as pump or fan start/stop

Part Number	Description			
2-way valves: the plug closes against the flow; 3-way valves: the plug blocks the flow toward user side				
DB-VZ2-15	2-way	DN15 (G 1/2)	1.6 Kvs	On/Off
DB-VZ2-20	2-way	DN20 (G 3/4)	3.5 Kvs	On/Off
DB-VZ2-25	2-way	DN25 (G 1)	5.5 Kvs	On/Off
DB-VZ3-15	3-way	DN15 (G 1/2)	1.6 Kvs	On/Off
DB-VZ3-20	3-way	DN20 (G 3/4)	3.5 Kvs	On/Off
DB-VZ3-25	3-way	DN25 (G 1)	5.5 Kvs	On/Off

SM ACTUATORS

Part Number	Description	
SM230/CA	230V With auxiliary microswitch	On/Off with manual override
SM24/CA	24V With auxiliary microswitch	On/Off with manual override

ROBUST PROTECTIVE COVER FOR CONTROL VALVES AND DAMPER ACTUATORS

If you have difficult operating conditions then it is the ideal solution for protecting your control valves in harsh environments. The BLUE BAG Series cover offers an innovative and effective weather protection solution for control valves and actuators. Made of heavy duty fabric, it gives significant protection against severe weather such as rain, sleet or snow.

The "Ice Blue" colour minimizes solar glare which keeps the protected equipment cooler than other forms of protection. It can be installed and removed in seconds and it is available in two sizes to fit various control valve assemblies.

Part Number	Description
BLUE BAG LARGE	Large outdoor protective cover suitable for most makes of motorised valves - 12x16 inches
BLUE BAG SMALL	Small outdoor protective cover suitable for most Makes of motorised valves - 10x12 inches



IBC stock over 2500 products
ready for immediate delivery



Serving the (BMS & HVAC)
Industry since 2005

ESBE

ROTARY MOTORISED MIXING VALVES

The ESBE VRG130 series is a range of compact low leakage mixing valves available in dimensions DN15–50 and made of special brass alloys for use in heating and cooling installations. Together with actuator series ESBE ARA600 the VRG130 valves are also easily automated

Part Number	Description		
VRG131-20	¾" bspf	6.3 Kvs	PN10, water -10/+110°C
VRG131-25	1" bspf	10 Kvs	PN10, water -10/+110°C
VRG131-32	1¼" bspf	16 Kvs	PN10, water -10/+110°C
VRG131-40	1½ bspf	25 Kvs	PN10, water -10/+110°C
VRG131-50	2" bspf	40 Kvs	PN10, water -10/+110°C

ESBE ARA600 ACTUATORS

The ESBE ARA600 series is a compact actuator designed for operating rotary mixing valves DN 15-50. The actuators ARA6X1, ARA6X2, ARA6X3 and ARA6X4 are controlled by 3-point signal, and are recommended for mixing applications. The actuator has an operating range of 90° and the valve can easily be manually operated by the pull-and-turn knob on the front of the actuator.

Part Number	Description		
ARA656	230v	2-point c/w aux switch	6Nm
ARA664	24v	3-point c/w aux switch	6Nm
ARA652	230v	3-point c/w aux switch	6Nm
ARA659	24v	0-10v	6Nm

ESBE F SERIES

The ESBE F series valve is available in dimensions DN 20-150 with flanged connections, and is made of cast iron for use in heating and cooling installations.

Part Number	Description		
3F50	50mm (FL)	66 Kvs	PN6, water -10/+110°C
3F65	65mm (FL)	100 Kvs	PN6, water -10/+110°C
3F80	80mm (FL)	150 Kvs	PN6, water -10/+110°C
3F100	100mm (FL)	225 Kvs	PN6, water -10/+110°C
3F125	125mm (FL)	310 Kvs	PN6, water -10/+110°C
3F150	150mm (FL)	420 Kvs	PN6, water -10/+110°C



Speak with our team
about any large projects



Order before 2pm for
same day dispatch

Contact our Rol sales team on +353 (0)1 457 5421 or email sales@ibc.ie



SAUTER VALVES

VUL/BUL UNIT VALVES

Unit Valves in cast brass, for use with AXT, AXS, OR AXM thermal or motorised valves



Part Number	Description		
VUL 010 F340	DN 10	0.16 Kvs	2-way
VUL 010 F330	DN 10	0.4 Kvs	2-way
VUL 010 F320	DN 10	0.63 Kvs	2-way
VUL 010 F310	DN 10	1 Kvs	2-way
VUL 010 F300	DN 10	1.6 Kvs	2-way
VUL 015 F310	DN 15	2.5 Kvs	2-way
VUL 015 F300	DN 15	3.5 Kvs	2-way
VUL 020 F300	DN 20	4.5 Kvs	2-way
BUL 010 F330	DN 10	0.4 Kvs	3-way
BUL 010 F320	DN 10	0.63 Kvs	3-way
BUL 010 F310	DN 10	1 Kvs	3-way
BUL 010 F300	DN 10	1.6 Kvs	3-way
BUL 015 F310	DN 15	2.5 Kvs	3-way
BUL 015 F300	DN 15	4 Kvs	3-way
BUL 020 F300	DN 20	5 Kvs	3-way
BUL 010 F430	DN 10	0.4 Kvs	3-way with T by-pass
BUL 010 F420	DN 10	0.63 Kvs	3-way with T by-pass
BUL 010 F410	DN 10	1 Kvs	3-way with T by-pass
BUL 010 F400	DN 10	1.6 Kvs	3-way with T by-pass
BUL 015 F410	DN 15	2.5 Kvs	3-way with T by-pass
BUL 015 F400	DN 15	4 Kvs	3-way with T by-pass
BUL 020 F400	DN 20	5 Kvs	3-way with T by-pass

AXT, AXS, & AXM ACTUATORS

Part Number	Description		
AXT 211F110	230V	115Nm	normally closed
AXT211F210	230V	110Nm	normally open
AXT 211F112	24V AC/DC	115Nm	normally closed
AXT 211F212	24V AC/DC	110Nm	normally open
AXS 215SF122	24V AC	115Nm	normally closed
AXS 215SF222	24V AC	110Nm	normally open
AXM 217F200	230V	120Nm	
AXM 217F202	24V AC/DC	120Nm	
AXM 217SF402	24V AC/DC	120Nm	
AXM 217SF404	24V AC/DC	160Nm	

VUN/BUN MALE THREAD VALVES

Male thread valves in cast brass for use with AVM linear actuators

Part Number	Description		
VUN 015 F350	DN 15	0.4 Kvs	2-way
VUN 015 F340	DN 15	0.63 Kvs	2-way
VUN 015 F330	DN 15	1 Kvs	2-way
VUN 015 F320	DN 15	1.6 Kvs	2-way
VUN 015 F310	DN 15	2.5 Kvs	2-way
VUN 015 F300	DN 15	4 Kvs	2-way
VUN 020 F300	DN 20	6.3 Kvs	2-way
VUN 025 F300	DN 25	10 Kvs	2-way
VUN 032 F300	DN 32	16 Kvs	2-way
VUN 040 F300	DN 40	22 Kvs	2-way
VUN 050 F300	DN 50	28 Kvs	2-way
VUN 050 F200	DN 50	40 Kvs	2-way
BUN 015 F330	DN 15	1 Kvs	3-way
BUN 015 F320	DN 15	1.6 Kvs	3-way
BUN 015 F310	DN 15	2.5 Kvs	3-way
BUN 015 F300	DN 15	4 Kvs	3-way
BUN 020 F300	DN 20	6.3 Kvs	3-way
BUN 025 F300	DN 25	10 Kvs	3-way
BUN 032 F300	DN 32	16 Kvs	3-way
BUN 040 F300	DN 40	22 Kvs	3-way
BUN 050 F300	DN 50	28 Kvs	3-way
BUN 050 F200	DN 50	40 Kvs	3-way

AVM ACTUATORS

Part Number	Description		
AVM 105F100	230V	250Nm	30s running time
AVM 105F120	230V	250Nm	120s running time
AVM 105F122	24V AC	250Nm	120s running time
AVM 105SF132	24V AC/DC	250Nm	35, 60s & 120s running time
AVM 115F120	230V	500Nm	120s running time
AVM 115F122	24V AC	500Nm	120s running time
AVM 115SF132	24V AC/DC	500Nm	60s & 120s running time
AVM 321F110	230V	1000Nm	96s & 48s running time
AVM 321F112	24V AC/DC	1000Nm	96s & 48s running time
AVM 321SF132	24V AC/DC	1000Nm	48s & 32s running time



VEXVE**VEXVE**
TERMOMIX ROTARY SHOE VALVES

Rotary shoe valves for 20-50mm, used with 3-point and Modulating (0 - 10V) actuators - Internally threaded, cast iron body - Suitable for medium temperature up to 110°C - Suitable for - mixing and diverting applications - Use with Gruner actuators and ET3 linkage

Part Number	Description		
2320	20mm Rotary Shoe Valve	3 Kvs	3 - way mixing valve
2325	25mm Rotary Shoe Valve	17 Kvs	3 - way mixing valve
2332	32mm Rotary Shoe Valve	24 Kvs	3 - way mixing valve
2340	40mm Rotary Shoe Valve	31 Kvs	3 - way mixing valve
2350	50mm Rotary Shoe Valve	41 Kvs	3 - way mixing valve
ET3	Linkage for Shoe Valve		

**SONTAY**
VZ ZONE VALVES

Part Number	Description
VZ-2N-15	2-Port valves
VZ-2N-20	2-Port valves
VZ-2N-25	2-Port valves
VZ-3-15	3-Port valves
VZ-3-20	3-Port valves
VZ-3-25	3-Port valves

**XUROX**
BUTTERFLY VALVES

A range of wafer type butterfly valves & actuators used in heating and cooling systems. Complete with Aluminium body - DN50-150, Stainless steel disc and shaft and EPDM seat.

Part Number	Description	
405WEHT40	40mm	50K vs
405WEHT50	50mm	83 Kvs
405WEHT65	65mm	212 Kvs
405WEHT80	80mm	400 Kvs
405WEHT100	100mm	750 Kvs
405WEHT125	125mm	1100 Kvs
405WEHT150	150mm	2000 Kvs

DAMPER ACTUATORS

JOHNSTON CONTROLS & JOVENTA ACTUATORS

The JOVENTA SILENCE electric damper-actuator series have been developed to operate small and medium air dampers in ventilation and air conditioning systems.

The compact design and universal adapter fitted with limitation of rotation angle make this JOVENTA actuator highly versatile.

2/3-point control, Load-independent running time, Up to 5 actuators in parallel - Plug-in terminal block connection - Simple direct mounting with universal adapter for fitting to Ø 6-mm to 16-mm shaft or with Z01DN adapter kit for 8,10,11 and 12 mm square shaft - Selectable direction of rotation - Manual release button - 2 adjustable auxiliary switches - Automatic shut-off at end position - Energy saving at end positions - Actuators available with 1m halogen-free cable - Customized versions available - Devices meet CE requirements

Johnston Part Number	Joventa Part Number	Description		
M9304-AGA-1N	DAN1.N	24c ac/dc	Floating	4Nm
M9304-AGC-1N	DAN1.SN	24c ac/dc	Floating	4Nm (2 aux switch)
M9304-ADA-1N	DAN2.N	230V	Floating	4Nm
M9304-ADC-1N	DAN2.SN	230V	Floating	4Nm (2 aux switch)
M9304-GGA-1N	DMN1.2N	24V dc	Proportional	4Nm
M9108-AGA-1N	DAS1	24c ac/dc	Floating	8Nm
M9108-AGC-1N	DAS1.S	24c ac/dc	Floating	8Nm (2 aux switch)
M9108-ADA-1N	DAS2	230V	Floating	8Nm
M9108-ADC-1N	DAS2.S	230V	Floating	8Nm (2 aux switch)
M9108-GGA-1N	DMS1.1	24V dc	Proportional	8Nm
M9108-GGC-1N	DMS1.1S	24V dc	Proportional	8Nm (2 aux switch)
M9116-AGA-1N	DA1	24c ac/dc	Floating	16Nm
M9116-AGC-1N	DA1.S	24c ac/dc	Floating	16Nm (2 aux switch)
M9116-ADA-1N	DA2	230V	Floating	16Nm
M9116-ADC-1N	DA2.S	230V	Floating	16Nm (2 aux switch)
M9116-GGA-1N	DM1.1	24V dc	Proportional	16Nm
M9116-GGC-1N	DM1.1S	24V dc	Proportional	16Nm (2 aux switch)
M9116-GDA-1N	DM2.2	230V dc	Proportional	16Nm
M9116-GDC-1N	DM2.2S	230V dc	Proportional	16Nm (2 aux switch)
M9124-AGA-1N	DAL1	24c ac/dc	Floating	24Nm
M9124-AGC-1N	DAL1.S	24c ac/dc	Floating	24Nm (2 aux switch)
M9124-ADA-1N	DAL2	230V	Floating	24Nm
M9124-ADC-1N	DAL2.S	230V	Floating	24Nm (2 aux switch)
M9124-GGA-1N	DML1.1	24V dc	Proportional	24Nm
M9124-GGC-1N	DML1.1S	24V dc	Proportional	24Nm (2 aux switch)

Johnson
Controls

JOVENTA®

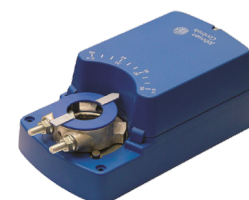



JOVENTA®



JOVENTA

Johnston Part Number	Joventa Part Number	Description	
	DBF1.03	24V Floating, run time 150 sec	3Nm
	DAF1.03	24V Floating, run time 60 sec	3 Nm
	DAF1.03S	24V Floating, run time 60 sec	3 Nm, (2 aux switch)
	DMF1.03	24V Proportional, run time 150 sec	3 Nm
	DMF1.03S	24V Proportional, run time 150 sec	3 Nm, (2 aux switch)
	DMF1.03SZ	24V Proportional, run time 90 sec	3 Nm, (2 aux switch)
M9208-AGA- 1	DBF1.08N	24V Floating, run time 150 sec	8 Nm
M9208-AGC- 1	DBF1.08SN	24V Floating, run time 150 sec	8 Nm, (2 aux switch)
M9208-BGA- 1	DAF1.08N	24V On/Off, run time 70 sec	8 Nm
M9208-BGC- 1	DAF1.08SN	24V On/Off, run time 70 sec	8 Nm, (2 aux switch)
M9208-BDA- 1	DAF2.08N	230V On/Off, run time 70 sec	8 Nm
M9208-BDC- 1	DAF2.08SN	230V On/Off, run time 70 sec	8 Nm, (2 aux switch)
	DA1.F	24V On/Off	16 Nm
	DA1.FS	24V On/Off	16 Nm, (2 aux switch)
	DM1.1F	24V Proportional	16Nm
	DM1.1FS	24V Proportional	16 Nm, (2 aux switch)
	DBF1.20S	230V Floating	20 Nm, (2 aux switch)
	DAF2.20	230V On/Off	20 Nm
	DAF2.20S	230V On/Off	20 Nm, (2 aux switch)
	DAF1.20	24V On/Off	20 Nm
	DAF1.20S	24V On/Off	20 Nm, (2 aux switch)
	DMF1.20	24V Proportional	20 Nm
	DMF1.20S	24V Proportional	20 Nm, (2 aux switch)
M9132-AGC- 1N	DAG1.S	230V Floating	32 Nm, (2 aux switch)
M9132-ADC-1N	DAG2.S	230V Floating	32 Nm, (2 aux switch)
Special and Security			
	SA1.12	24V Floating	8Nm
	SA1.12S	24V Floating	8 Nm, (2 aux switch)
M9108-GGA- 1N4	SM1.12	24V Proportional	8 Nm
M9108-GGC- 1N4	SM1.12S	24V Proportional	8 Nm, (2 aux switch)
M9116-AGA- 1N4	SA1.10	24V Floating	16 Nm
M9116-AGC- 1N4	SA1.10S	24V Floating	16 Nm, (2 aux switch)
M9116-GGA- 1N4	SM1.10	24V Proportional	16 Nm
M9116-GGC- 1N4	SM1.10	24V Proportional	16 Nm, (2 aux switch)

BELIMO

Part Number	Description		
LM24A	5 Nm	24V	2- or 3-position
LM24A-S	5 Nm	24V	2- or 3-position c/w aux switch
LM24A-SR	5 Nm	24V	2-10v output
LM230A	5 Nm	230V	2- or 3-position
LM230A-S	5 Nm	230V	2- or 3-position c/w aux switch
NM24A	10 Nm	24V	2- or 3-position
NM24A-S	10 Nm	24V	2- or 3-position c/w aux switch
NM24A-SR	10 Nm	24V	2-10v output
NM230A	10 Nm	230V	2- or 3-position
NM230A-S	10 Nm	230V	2- or 3-position c/w aux switch
SM24A	20 Nm	24V	2- or 3-position
SM24A-S	20 Nm	24V	2- or 3-position c/w aux switch
SM24A-SR	20 Nm	24V	2-10v output
SM230A	20 Nm	230V	2- or 3-position
SM230A-S	20 Nm	230V	2- or 3-position c/w aux switch
GM24A	30 Nm	24V	2- or 3-position
GM24A-SR	30 Nm	24V	2-10v output
GM230A	30 Nm	230V	2- or 3-position

Part Number	Description		
LF24	4 Nm	24V	2-position spring returnw
LF24-S	4 Nm	24V	2-position spring return c/w aux switch
LF24-SR	4 Nm	24V	2-10v output spring return
LF230	4 Nm		2-position spring return
LF230-S	4 Nm		2-position spring return c/w aux switch
NF24A	10 Nm	24V	2-position spring return
NF24A-S2	10 Nm	24V	2-position spring return c/w 2x aux switch
NF24A-SR	10 Nm	24V	2-10v output spring return
NFA	10 Nm	24-240V	2-position spring return
NFA-S2	10 Nm	24-240V	2-position spring return c/w 2x aux switch
SF24A	20 Nm	24V	2-position spring return
SF24A-S2	20 Nm	24V	2-position spring return c/w 2x aux switch
SF24A-SR	20 Nm	24V	2-10v output spring return
SFA	20 Nm	24-240V	2-position spring return
SFA-S2	20 Nm	24-240V	2-position spring return c/w 2x aux switch
GK24A-1	40 Nm	24V	2-position electrical failsafe
GK24A-SR	40 Nm	24V	2-10v output electrical failsafe

BELIMO



04

METERS

Contents

Meters

Onicon	59
Kamstrup	63
Danfoss	66
Aquamotion	67
Vemm Tec	69
Sigma	70
Aquametro	71



Click the page number to
Navigate to the relevant page

Onicon Flow Meters

ONICON Incorporated has been a leading provider of the flow and energy measurement solutions required by the HVAC industry for more than 30 years.

Delivering engineered products - ready to use right out of the box. All ONICON products are custom configured for your application and receive an industry traceable wet calibration. Our goal is to provide industry leading application and technical support as well as exceptional sales and customer service assistance. Please contact our office if you require additional help.



F-1000 SERIES TURBINE FLOW METERS

The F-1000 Series family of inline and insertion style turbine flow meters are designed to provide accurate and reliable flow measurement in a variety of applications in the HVAC market.

ONICON's F-1000 Series is a family of insertion and inline style turbine flow meters that provide accurate, reliable flow measurement in a variety of applications.

The F-1000 Series flow meters are suitable for use in pipes ranging in size from 3/4" to 72" in diameter. Each model utilizes ONICON's patented electronic turbine rotation sensing system and unique low mass turbine design that is accurate over wide flow ranges with excellent low flow measurement capability.



D-100 FLOW DISPLAY MODULE

The D-100 is a totalizing display module that provides a local indication of liquid or steam flow rate and total data. The flexible design can also be configured with an optional network interface to communicate flow data to the building control network. It is housed in a steel wall mounted enclosure with a built-in user interface/display. The standard flow input accepts 4-20 mA, pulse or contact closure flow signals. The versatile D-100 can also function as a network interface for 2 additional analog rate inputs and one additional totalizing pulse input. It can also be configured with up to 4 optional analog outputs.



**LEADING THE WAY
SINCE 1987**



Speak with our team
about any large projects



Order before 2pm for
same day dispatch



Onicon Flow Meters

F-3500 SERIES INSERTION ELECTROMAGNETIC FLOW METERS

ONICON's F-3500 series insertion electromagnetic flow meters are suitable for measuring electrically conductive liquids in a wide variety of applications. Each F-3500 provides a single analog output for flow rate, a high resolution frequency output to drive peripheral devices, a scalable pulse output for totalization, and an empty pipe alarm signal.

Two versions of the F-3500 are available. The standard configuration F-3500 is suitable for pipe sizes ranging from 3" to 72" in diameter. The small pipe configuration F-3500 is suitable for pipes ranging in size from 1½" to 2½" in diameter. Optional remote displays and BTU measurement systems are also available for both versions.



D-1200 FLOW METER DISPLAY MODULE

ONICON's D-1200 series is a family of remote displays for indication of flow rate and total volume for a variety of applications.

D-1200 series displays are modular flow display centers that convert ONICON insertion and inline flow meters into complete flow monitoring stations. The wall-mounted modules display the current flow rate and total and provide a low voltage DC power source capable of powering most ONICON inline and insertion flow meters.

The versatile display module can be located close to the flow meter or up to several hundred feet away. Using the flow meter with the display module will also allow you to support other remote devices such as BTU meters, building control systems, and data acquisition systems.



F-3500 INSERTION
ELECTROMAGNETIC FLOW METER

**HOT-TAPPABLE AND RETROFIT
CAPABLE HYDRONIC HVAC
FLOW METER**

Onicon Flow Meters



FT-3000 SERIES INLINE ELECTROMAGNETIC FLOW METER

The FT-3000 Series family of inline flow meters are designed to provide accurate and reliable flow measurements for a variety of challenging applications in the HVAC market.

ONICON FT-3000 Series Inline Electromagnetic Flow Meters are suitable for measuring electrically conductive liquids in a wide variety of applications. The FT-3000 series provides analog and digital outputs for flow rate and programmable pulse outputs for flow totalization and/or alarms.



F-4600 INLINE ULTRASONIC FLOW METER

The F-4600 series is a family of inline flow meters that provide accurate, reliable flow measurement for a variety of applications. ONICON Inline Ultrasonic Flow Meters accurately and reliably measure the flow of water and water glycol solutions in pipe sizes ranging from ½" to 2½". These cost-effective meters have excellent low-flow measurement capabilities, and the unique flow tube design accurately measures flow in very limited straight run installations.



SYSTEM-10 BTU METERS

The System-10 is the most versatile energy (BTU) measurement system ONICON offers. It utilizes a matched pair of calibrated temperature sensors combined with one of ONICON's custom configured flow meters (ordered separately). The versatile design is available with a vast array of output options which include RS485 and IP serial networks, multiple pulse outputs, auxiliary pulse inputs and multiple analog outputs.

FEATURES

- Configured to match the accuracy and performance requirements of the application
- Delivered fully calibrated, programmed and ready to use
- Network interface options:
 - BACnet MS/TP
 - BACnet/IP (UDP/IP)*
 - MODBUS RTU (RS485)
 - MODBUS TCP/IP
 - LonWorks (FTT-10)





ONICON's System-20 and System-40 BTU Meters utilize a BACnet MS/TP serial interface that is certified by the BACnet® Testing Laboratory (BTL).

SYSTEM-20 BTU METERS

The System-20 is designed to measure the thermal energy associated with the most common systems found in today's HVAC applications and communicate directly with the BMS/BAS. This flexible design will provide energy, flow and temperature data on the local display and over the BACnet MS/TP or MODBUS RTU networks. In addition, the System-20 provides an analog output signal, pulse outputs, and auxiliary pulse inputs, all of which are configurable via an intuitive user interface.

FEATURES

- Delivered fully calibrated, programmed, and ready to use
- Provides the most common communication options and outputs used in the HVAC industry
- Network interface options: BACnet MS/TP* and MODBUS RTU (RS485)

SYSTEM-40 BTU METERS

The System-40 is a complete BTU measurement system ideally suited for sub-metering applications. It includes a pair of matched temperature sensors, an integral inline ultrasonic flow sensor, and local/remote display. It communicates via BACnet® MS/TP or MODBUS® RTU. A configurable output array consisting of a combination of pulse outputs, an optional analog output, and three auxiliary pulse inputs that provide a means for other devices, such as utility meters, to connect to the BAS through the System-40's serial network connection.

FEATURES

- Accurate, reliable, no-moving-parts, wetted ultrasonic flow sensor
- Individually wet-calibrated and delivered fully programmed and ready to use upon delivery
- Network interface options: BACnet MS/TP* and MODBUS RTU (RS485)



The ideal, non-invasive tool for testing and validating liquid flow

FP-4400

Portable Clamp-on Ultrasonic Flow Meter

- Wide flow range – 400:1 turndown from 0.1 to 40 ft/s
- One instrument for ½" to 48" pipe sizes
- Built-in 12 million point data logger
- Easy set-up via intuitive menus
- Up to 15 hours of battery life
- ±1% of reading accuracy

Represented locally by



Kamstrup Heating & Cooling Meters

KAMSTRUP MULTICAL® 403

- Compact energy meter for heat, cooling & combined heat/cooling
- MID Class 2 Approved for heat
- DK-BEK 1178 Approved for cooling
- On-site configurable flow or return installation positions
- Suitable for water-based systems
- Interchangeable components to suit specific requirements



Part Number	Size (mm)	Nom. flow q_p (m ³ /hr)	Max. flow q_s (m ³ /hr)	Min. flow q_i (m ³ /hr)	Body length (mm)
403x10xxx	15	0.6	1.2	0.006	110
403x30xxx	20	0.6	1.2	0.006	190
403x40xxx	15	1.5	3.0	0.015	110
403x50xxx	15	1.5	3.0	0.015	165
403x60xxx	20	1.5	3.0	0.015	110
403x70xxx	20	1.5	3.0	0.015	130
403x80xxx	20	1.5	3.0	0.015	165
403x90xxx	20	1.5	3.0	0.015	190
403xA0xxx	20	2.5	5.0	0.025	130
403xB0xxx	20	2.5	5.0	0.025	190
403xD0xxx	25	3.5	7.0	0.035	260
403xF0xxx	25	6.0	12	0.06	260
403xG0xxx	DN25	6.0	12	0.06	260
403xH0xxx	40	10	20	0.1	300
403xJ0xxx	DN40	10	20	0.1	300
403xK0xxx	DN50	15	30	0.15	270

kamstrup



KAMSTRUP MULTICAL® 603

- Modular communication outputs - 2 slots
- Auto Detect of ULTRAFLOW®
- MID Class 2 Approved for heat
- DK-BEK 1178 Approved for cooling
- On-site configurable flow or return installation positions
- 2 or 4 wire temperature sensor options



kamstrup**MULTICAL® COMMUNICATION MODULES**

- Comes with Serial Identification Number
- Latest QR technology to identify data sheet
- Various options available



Part Number	Description
HC-003-10	Data + 2 Pulse Inputs
HC-003-11	Data + 2 Pulse Outputs
HC-003-20	M-Bus, Configurable + 2 Pulse Inputs
HC-003-21	M-Bus, Configurable + 2 Pulse Outputs
HC-003-30	Wireless M-Bus 868 Mhz + 2 Pulse Inputs
HC-003-31	Wireless M-Bus 868 Mhz + 2 Pulse Outputs
HC-003-40	Analog Outputs, 0/4...20mA*
HC-003-41	Analog Outputs, 0/4...20mA* / 0...10V*
HC-003-43	PQT Controller*
HC-003-51	Low Power Radio, GDPR + 2 Pulse Inputs
HC-003-60	LON FT-X3 + 2 Pulse Inputs**
HC-003-66	BACnet (RS-485) + 2 Pulse Inputs*
HC-003-67	Modbus RTU (RS-485) + 2 Pulse Inputs*
HC-003-80	2G/4G Network**
HC-003-82	Modbus RTU/KMP TCP/IP + 2 Pulse Inputs**
HC-003-85	High Power Radio, GDPR + 2 Pulse Inputs

* The meter must be mains supplied

** The meter must be high power supplied

MULTICAL® ACCESSORIES**SIGNAL CABLES**

Part Number	Size (m)
50-00-333	2.5
50-00-259	5
50-00-270	10

CONFIGURATION TOOLS

Part Number	Size (m)
66-99-099	USB Optical Eye
66-99-102	RS232 Optical Eye
66-99-035	Module Configurator

TRANSMITTER AND EXTENDER BOX

Part Number	Description
66-99-903-20	Transmitter Box
66-99-036	Cable Extender Box

WALL BRACKETS

Part Number	Size (m)
30-26-655	403 Wall Bracket
30-26-207.A	603 Wall Bracket
59-15-574	803 Wall Bracket

ULTRAFLOW® FLOW SENSORS - FLANGED

- Static Meter with no moving parts
- For flow rates from 1.5 m³/h to 1000 m³/h
- No Wear and exceptional longevity
- 2.5m Signal Cable as standard
- PN25 Flanged Connection (DN300 PN16)

Part Number	Size (mm)	Nom. flow q_p (m ³ /hr)	Max. flow q_s (m ³ /hr)	Min. flow q_i (m ³ /hr)	Body length (mm)
65-X-CDCA-XXX	20	1.5	3.0	0.015	190
65-X-CECA-XXX	20	2.5	5.0	0.025	190
65-X-CGCB-XXX	25	3.5	7.0	0.035	260
65-X-CHCB-XXX	25	6.0	12.0	0.060	260
65-X-CHCC-XXX	32	6.0	12.0	0.060	260
65-X-CJCD-XXX	40	10.0	20.0	0.100	300
65-X-CKCE-XXX	50	15.0	30.0	0.150	270
65-X-CLCG-XXX	65	25.0	50.0	0.250	300
65-X-CMCH-XXX	80	40.0	80.0	0.400	300
65-X-FACL-XXX	100	60.0	120.0	0.600	360
65-X-FBCM-XXX	125	100.0	200.0	1.000	350
65-X-FCCN-XXX	150	150.0	300.0	1.500	500
65-X-FDCN-XXX	150	250.0	500.0	2.500	500
65-X-FECP-XXX	200	400.0	800.0	4.000	500
65-X-FFCP-XXX	200	600.0	1200.0	6.000	500
65-X-FFCR-XXX	250	600.0	1200.0	6.000	600
65-X-FGDS-XXX	300	1000.0	2000.0	10.000	500

kamstrup



ULTRAFLOW® FLOW SENSORS - THREADED

- For flow from 0.6m³/h to 10 m³/h
- Static Meter with no moving parts
- Large dynamic range
- No Wear and exceptional longevity
- PN16 Threaded Connection

Part Number	Size (mm)	Nom. flow q_p (m ³ /hr)	Max. flow q_s (m ³ /hr)	Min. flow q_i (m ³ /hr)	Body length (mm)
65-X-CAHA-XXX	15	0.6	1.2	0.006	110
65-X-CAHD-XXX	20	0.6	1.2	0.006	130
65-X-CDHA-XXX	15	1.5	3.0	0.015	110
65-X-CDHC-XXX	15	1.5	3.0	0.015	165
65-X-CDHD-XXX	20	1.5	3.0	0.015	130
65-X-CDHF-XXX	20	1.5	3.0	0.015	190
65-X-CEHD-XXX	20	2.5	5.0	0.025	130
65-X-CEHF-XXX	20	2.5	5.0	0.025	190
65-X-CGJG-XXX	25	3.5	7.0	0.035	260
65-X-CHJG-XXX	25	6.0	12.0	0.06	260
65-X-CHJH-XXX	32	6.0	12.0	0.06	260
65-X-CJJJ-XXX	40	10.0	20	0.10	300



kamstrup**FLOWIQ® 3100**

- MID Approved, MI-001, Accuracy Class 2
- Remote Reading Options
- 16 Year Battery



Part Number	Size (mm)	Nom. flow q_p (m ³ /hr)	Max. flow q_s (m ³ /hr)	Min. flow q_i (m ³ /hr)	Body length (mm)
031-YY-C03-XXX	25	4.0	5.0	0.04	175
031-YY-C0J-XXX	40	10.0	12.5	0.10	300
031-YY-C0L-XXX	50	16.0	20.0	0.16	270
031-YY-C0M-XXX	65	25.0	31.0	0.25	300
031-YY-C0N-XXX	80	40.0	50.0	0.40	300

Danfoss**Danfoss Energy Meters****DANFOSS SONO30 ULTRASONIC ENERGY METERS**

The Danfoss Sono30 is a range of ultrasonic, compact energy meters intended for measuring energy consumption in heating and cooling applications for billing purposes.



Part Number	Size (DN)	Nom Flow (m ³ /h)
SONO30/15/1.5	15	1.5
SONO30/20/2.5	20	2.5
SONO30/25/3.5	25	3.5
SONO30/25/6.0	25	6
SONO30/40/10	40	10
SONO30/50/15	50	15
SONO30/65/25	65	25
SONO30/80/40	80	40
SONO30/100/60	100	60

FEATURES

- MID Approved Class II
- DN15-40 (Screwed) - suitable for heating & cooling as standard
- M-Bus & 2 x Pulse input/output as standard
- BACnet & Modbus options available
- Battery as standard, 230v or 24v available please specify
- Meters complete with 1.5m temperature sensors, pockets & connections
- DN15-20 meters - return sensor mounted directly into supplied to allow flow sensor to be mounted direct into line/media

Options

RS-485 MODBUS MODULE

BACnet OPTION

3M TEMP SENSORS

5M TEMP SENSORS

10M TEMP SENSORS

NOTE: To be mounted in return line as standard, flow versions available on request

Aquamotion Water Meters



MJC MULTI JET COLD WATER METER

- Super Dry, Sealed Register
- MID Approved, MI-001 R80, Accuracy Class 2
- Pressure Rated to 16 Bar



Part Number	Size (mm)	Nom. flow q_p (m ³ /hr)	Max. flow q_s (m ³ /hr)	Min. flow q_i (m ³ /hr)	Body length (mm)
S15MJC	15	2.5	3.13	0.03	165
S20MJC	20	4.0	5.0	0.05	190
S25MJC	25	6.3	7.88	0.07	260
S32MJC	32	10.0	12.5	0.12	260
S40MJC	40	16.0	20.0	0.20	300
S50MJC	50	25.0	31.3	0.31	300



MJH MULTIJET HOT WATER METER

- Super Dry, Sealed Register
- MID Approved, MI-001 R80, Accuracy Class 2
- Pressure Rated to 16 Bar



Part Number	Size (mm)	Nom. flow q_p (m ³ /hr)	Max. flow q_s (m ³ /hr)	Min. flow q_i (m ³ /hr)	Body length (mm)
S15MJH	15	2.5	3.13	0.03	165
S20MJH	20	4.0	5.0	0.05	190
S25MJH	25	6.3	7.8	0.07	260
S32MJH	32	10.0	12.5	0.12	260
S40MJH	40	16.0	20.0	0.20	300
S50MJH	50	25.0	31.3	0.31	300



Speak with our team
about any large projects



Order before 2pm for
same day dispatch

Contact our Rol sales team on +353 (0)1 457 5421 or email sales@ibc.ie



WC WOLTMANN COLD WATER METER

- Super Dry, Sealed Register
- MID Approved, MI-001 R80, Accuracy Class 2
- Pressure Rated to 16 Bar



Part Number	Size (mm)	Nom. flow q_p (m ³ /hr)	Max. flow q_s (m ³ /hr)	Min. flow q_i (m ³ /hr)	Body length (mm)
F50WC	50	40	50	0.50	200
F65WC	65	63	78	0.78	200
F80WC	80	63	78	0.78	225
F100WC	100	100	125	1.25	250
F125WC	125	160	200	2.00	250
F150WC	150	250	313	3.13	300
F200WC	200	400	500	5.00	350

WH WOLTMANN HOT WATER METER

- Super Dry, Sealed Register
- Pressure Rated to 16 Bar
- Factory tested to MID Standards



Part Number	Size (mm)	Nom. flow q_p (m ³ /hr)	Max. flow q_s (m ³ /hr)	Min. flow q_i (m ³ /hr)	Body length (mm)
F50WH	50	40	50	0.50	200
F65WH	65	63	78	0.78	200
F80WH	80	63	78	0.78	225
F100WH	100	100	125	1.25	250
F125WH	125	160	200	2.00	250
F150WH	150	250	313	3.13	300
F200WH	200	400	500	5.00	350



Speak with our team
about any large projects



Order before 2pm for
same day dispatch

Vemm Tec Gas Meters

vemmtec
 Messtechnik GmbH

IGTM TURBINE GAS METER

- Wafer Pattern 'Sandwich' Type
- 8 Digit Mechanical Counter
- Lightweight Aluminium Body
- Suitable for non-aggressive gases



Part Number	Size (mm)	Min. flow q_p (m ³ /hr)	Max. flow q_s (m ³ /hr)	Body length (mm)
IGTM DN50 G40/65	50	10	100	120
IGTM DN65 G65/100	65	13	160	120
IGTM DN80 G100/160	80	10	250	120
IGTM DN80 G250	80	20	400	120
IGTM DN100 G160/250	100	13	400	150
IGTM DN100 G400	100	32	650	150
IGTM DN150 G400/650	150	32	1000	180
IGTM DN150 G1000	150	80	1600	180
IGTM DN200 G650/1000	200	50	1600	200
IGTM DN200 G1600	200	130	2500	200



IGQM TURBINE GAS METER

- Compact Dimensions
- 7 Digit Mechanical Counter
- Lightweight Aluminium Body
- Suitable for non-aggressive gases



Part Number	Size (mm)	Min. flow q_p (m ³ /hr)	Max. flow q_s (m ³ /hr)	Body length (mm)
IGQM-10	25	1.6	16	185
IGQM-16	25	2	25	185
IGQM-25	25	2.5	40	185
IGQM-40	40	5	65	126

Reducers Available 3/4" & 1 1/4"



Large selection of Meters in
 stock ready for delivery



Serving the (BMS & HVAC)
 Industry since 2005

Contact our Rol sales team on +353 (0)1 457 5421 or email sales@ibc.ie



Sigma Gas Meters

DIAPHRAGM GAS METER INSTALLATION KIT

Installation kits include everything you need to complete a domestic gas meter installation. This kit is supplied as a complete package that consists of an MID Approved domestic Gas Meter, Gas Regulator, Control Valve, Flexi Hose, Unions and Wall Bracket.



Part Number	Comprising of
G4 Installation Kit	3/4" Diaphragm Gas Meter
	3/4" Diaphragm Gas Meter Bracket
	3/4" Meter Flexible Hose
	3/4" Diaphragm Gas Meter Union Kit
	3/4" Angled Gas Regulator
	3/4" Meter Control Valve

UG DIAPHRAGM GAS METER

- BSP Screwed Connection
- MID Approved 2014/32/EU
- Low Pressure Drop
- Suitable for low flow rates



Part Number	Size (mm)	Min. flow q_i (m ³ /hr)	Max. flow q_s (m ³ /hr)	Pipe Centres (mm)
UG-G4P	20	0.04	6	110
UG-G6P	25	0.06	10	250
UG-G10P	30	0.10	16	250
UG-G16P	40	0.16	25	280
UG-G25P	50	0.25	40	280

Reducers Available 3/4" & 1 1/4"



Speak with our team
about any large projects



Order before 2pm for
same day dispatch

Aquametro Oil Meters

VZO RANGE

- Mechanical Roller Counter
- Pulse Output Available
- Rated to 130°C (VZO4 & VZO8 - 80°C)
- Suitable for pressures up to 16 Bar



Part Number	Size (mm)	Min. flow q_i (l/hr)	Max. flow q_s (l/hr)	Body length (mm)
VZO4	4	1	80	N/A
VZO8	8	4	200	N/A
VZO15	15	10	600	165
VZO20	20	30	1500	165
VZO20	25	75	3000	190
VZO40	40	225	9000	300



VZF RANGE

- Mechanical Roller Counter
- Pulse Output Available
- Rated to 130°C
- Suitable for pressures up to 25 Bar



Part Number	Size (mm)	Min. flow q_i (l/hr)	Max. flow q_s (l/hr)	Body length (mm)
VZO15FL	15	10	600	165
VZO20FL	20	30	1500	165
VZO25FL	25	75	3000	190
VZO40FL	40	225	9000	300
VZO50FL	50	750	30000	350



VZFII RANGE

- Digital Counter
- Pulse or Analogue Outputs
- Rated to 130°C
- Pressures up to 16 Bar (Screwed) 25 Bar (Flanged)



Part Number	Size (mm)	Min. flow q_i (l/hr)	Max. flow q_s (l/hr)	Body length (mm)
VZFII-15	15	10	600	165
VZFII-20	20	30	1500	165
VZFII-25	25	75	3000	190
VZFII-40	40	225	9000	300
VZFII-50	50	750	30000	350



05

SENSORS

Contents

Sensors

Temperature & Humidity

Industrie Technik	73
Sontay	81
IBC	91
Axio	92
Alre	93

Light & Occupancy

Sontay	94
Axio	95

Air Pressure & Velocity

Air Monitor	96
Sontay	97

Liquid Level, Flow & Pressure

Sontay	101
--------	-----

Power Sensors

Grystone, ACI, Functional Devices Inc.	105
--	-----



Click the page number to
Navigate to the relevant page

Temperature & Humidity

ROOM HUMIDISTAT

Electromechanical humidistat for room mounting with synthetic element.

Technical data	
Sensor element	Synthetic element
Switch capacity	Humidify: 2 (1) A, 230 V AC Dehumidify: 5 (1) A, 230 V AC
Setpoint	30...100 % RH
Dimensions	115 x 70 x 35 mm
Protection class	IP20

Part Number	Hidden setpoint
DBZH-101	-
DBZH-101U	X

ROOM HUMIDISTAT

Electromechanical humidistat with a synthetic element. The setpoint knob can be locked.

Technical data	
Sensor element	Synthetic element
Output	One, 230 V AC, 5 A, change-over
Setpoint	35...95 % RH
Dimensions	86 x 86 x 30 mm
Protection class	IP30

Part Number	Description
DBZH-102	Room humidistat, 1-step

DUCT HUMIDISTAT

Humidistat to be mounted in the duct.

Technical data	
Sensor element	Synthetic element
Switch capacity	15 (2) A, 230 V AC 0.25 A, 230 V DC
Humidity range	30...100 % RH
Tube length	220 mm
Material, tube	Nickel-plated brass, perforated
Dimensions	108 x 70 x 72 mm

Part Number	Hidden setpoint	Protection class
DBKH-10	-	IP54
DBKH-10U	X	IP65





DUCT/WALL HUMIDISTAT

Electromechanical humidistat with change-over contact.

Technical data

Sensor element	Human hair
Output	10 A, 250 V AC, change-over
Setpoint	10...100 % RH
Dimensions	80 x 85 x 88 mm
Protection class	IP54
Mounting	Duct or Wall
Hysteresis	3 % RH

Part Number	Description	Output	Step differential
DBKH-10H	Duct/wall humidistat	1-step	-
DBKH-20H	Duct/wall humidistat	2-step	0...25 % RH

HUMIDITY TRANSMITTER FOR ROOM MOUNTING, OUTPUT 0...10 V, IP30

Transmitters for relative humidity and temperature measurement. They have good long-term stability and are resistant to contamination.

Technical data

Supply voltage	24 V AC \pm 10% / 15...35 V DC
Output signal	0...10 V DC or Modbus
Working range, humidity	0...100 % RH
Accuracy, humidity	\pm 3 % RH at 20 °C
Dimensions	100 x 85 x 30.5 mm
Protection class	IP30
Working range, temperature	0...50 °C
Working range, humidity	0...100 % RH

Part Number	Output signal	Display
TUA-M	Modbus	-
TUA-D-M	Modbus	X
TUA	-0...10 V DC	-
TUA-D	0...10 V DC	X



IBC stock over 2500 products ready for immediate delivery



Serving the (BMS & HVAC) Industry since 2005

HUMIDITY TRANSMITTER FOR ROOM MOUNTING, OUTPUT 4...20 MA, IP30

Technical data	
Supply voltage	Max 28 V DC, Min (11+(0,02xRL)) V DC
Output signal	4...20 mA (2 wire)
Accuracy, humidity	±3 % RH at 20 °C
Dimensions	100 x 85 x 30.5 mm
Protection class	IP30
Power consumption	0,6 W
Ambient temperature	0...50 °C
Ambient humidity	0...95% RH (non condensing)
Working range, humidity	0...100 % RH (non condensing)
Accuracy, humidity	±3 % RH at 20 °C

Part Number	Display
TUA-C	-
TUA-CD	X

HUMIDITY AND TEMPERATURE TRANSMITTER FOR ROOM MOUNTING, 4...20 MA

Technical data	
Supply voltage	Max. 28 V DC, Min. 11+(0.02xRL) V DC
Output signal	4...20 mA (2 wire)
Accuracy, humidity	±3% RH at 20 °C
Accuracy, temperature	±0.5°C at 20°C
Dimensions (WxHxD mm)	100 x 85 x 30.5
Protection class	IP30
Power consumption	1.2 W
Ambient temperature	0...50 °C
Ambient humidity	0...95 % RH (non-condensing)
Humidity range	0...100 % RH

Part Number	Display
TTUA-C	-
TTUA-CD	X



Speak with our expert
BMS engineers today



Online training available
please speak with our team

Contact our Rol sales team on +353 (0)1 457 5421 or email sales@ibc.ie



HUMIDITY TRANSMITTER FOR ROOM MOUNTING, OUTPUT 4...20 MA, IP30

Technical data

Supply voltage	24 V AC $\pm 10\%$ / 15...35 V DC
Working range, temperature	0...50 °C
Working range, humidity	0...100 % RH
Accuracy, humidity	$\pm 3\%$ RH at 20°C
Dimensions	100 x 85 x 30.5 mm
Protection class	IP30

Part Number	Description	Display	Output signal	Accuracy, temperature
TTUA	RH + °C	-	0...10 V + 0...10 V	$\pm 0.4\text{ °C}$
TTUA-PT100	RH + PT100, 100 Ohm (0°C)	-	0...10 V + ohm	$\pm 0,3\text{ °C}$
TTUA-PT1000	RH + PT1000, 1000 Ohm (0°C)	-	0...10 V + ohm	$\pm 0,3\text{ °C}$
TTUA-D	RH + °C	X	0...10 V + 0...10 V	$\pm 0.4\text{ °C}$
TTUA-D-PT100	RH + PT100, 100 Ohm/0°C	X	0...10 V + ohm	$\pm 0,3\text{ °C}$
TTUA-D-PT1000	RH + PT1000, 1000 Ohm (0°C)	X	0...10 V + ohm	$\pm 0,3\text{ °C}$
TTUA-M	RH + °C	-	Modbus	$\pm 0.4\text{ °C}$
TTUA-D-M	RH + °C	X	Modbus	$\pm 0.4\text{ °C}$

TEMPERATURE TRANSMITTER FOR ROOM MOUNTING, 0...10 V AND MODBUS

Technical data

Supply voltage	24 V AC $\pm 10\%$ / 15...35 V DC
Display	4 digit
Dimensions 100 x 85 x 30.5 mm	100 x 85 x 30.5 mm
Protection class	IP30

Part Number	Output signal	Accuracy	Display
TTA	0...10 V DC	$\pm 0.4\text{ °C}$	-
TTA-D	0...10 V DC	$\pm 0.4\text{ °C}$	X
TTA-M	Modbus	$\pm 0.4\text{ °C}$	-
TTA-D-M	Modbus	$\pm 0.4\text{ °C}$	X



Speak with our team
about any large projects



Order before 2pm for
same day dispatch

TEMPERATURE TRANSMITTER FOR ROOM MOUNTING, 4...20 MA

Technical data		
Supply voltage	Max. 28 V DC, Min. 11+(0.02xRL) V DC	
Accuracy, temperature	±0.5°C at 20°C	
Dimensions (WxHxD mm)	100 x 85 x 30.5	
Protection class	IP30	

Part Number	Output signal	Display
TTA-CD	4...20 mA (2 wires)	X (4 digits)
TTA-C	4...20 mA (2 wires)	-

WALL THERMOSTAT, IP65

High quality thermostats for use in cooling, heating and ventilation systems.

Technical data					
Sensor element	Liquid-filled coiled copper bulb				
Switch capacity	15 (8) A, 24...250 V AC				
Dimensions	108 x 70 x 72 mm				
Weight	450 g				
Protection class	IP65				

Part Number	Temperature range	Steps	Hysteresis	Step diff.	Hidden setpoint
DBET-22	-30...+30 °C	1	2...15 K	-	-
DBET-22U	-30...+30 °C	1	2...15 K	-	X
DBET-23	-30...+30 °C	1	1 K	-	-
DBET-22/2	-30...+30 °C	2	1 K	2...5 K	-
DBET-26	0...60 °C	1	2...15 K	-	-
DBET-27	0...60 °C	1	1 K	-	-
DBET-26U	0...60 °C	1	2...15 K	-	X
DBET-26/2	0...60 °C	2	1 K	2...5 K	-
DBET-22/2U	-30...+30 °C	2	1 K	2...5 K	X
DBET-23U	-30...+30 °C	1	1 K	-	X
DBET-26/2U	0...60 °C	2	1 K	2...5 K	X
DBET-27U	0...60 °C	1	1 K	-	X



Large selection of Sensors in stock ready for delivery



Serving the (BMS & HVAC) Industry since 2005

Contact our Rol sales team on +353 (0)1 457 5421 or email sales@ibc.ie



DUCT THERMOSTAT, IP54

A range of high quality duct thermostats.

Technical data

Sensor element	Liquid-filled coiled copper bulb with 200 mm protection spring and mounting bracket
Switch capacity	TZ090U: NC 16 (6) A, 250 V AC, NO 6 (4) A, 250 V AC / TZR6585: NC 16 (2,5) A, 250 V AC, NO 0,5 A, 250 V AC
Insertion length	185 / Ø 21 mm
Dimensions	108 x 70 x 72 mm
Protection class	IP54

Part Number	Temperature range	Hysteresis	Max. bulb temp.	Function	Hidden setpoint
TZ090U	0...90 °C	4±1 K	120 °C	With SPDT contact	X
TZR6585	65...85 °C	20±5 K	125 °C	Manual maximum reset	-

ACCESSORIES

Part Number	Description
DBZ-25	Spiral protection bracket for capillary

Note: the thermostats are supplied with spiral protection bracket model DBZ-25.

The device can only be triarmed if the temperature falls below the setpoint minus the hysteresis value.

CLAMP-ON THERMOSTAT, IP65

Thermostats for use in cooling, heating and ventilation systems.

Technical data

Sensor element	Liquid-filled coiled copper bulb for contact
Switch capacity	15 (8) A, 24...250 V AC
Protection class	IP65 class I
Dimensions	108 x 70 x 72 mm

Part Number	Temperature range	Max. bulb temperature	Function
DBAT-3	0...60 °C	75 °C	-
DBAT-3U	0...60 °C	75 °C	X
DBAT-5	20...90 °C	95 °C	-
DBAT-5U	20...90 °C	95 °C	X



Speak with our team
about any large projects



Order before 2pm for
same day dispatch

IMMERSION THERMOSTATS, IP 54

Temperature control in pipes for heating, cooling and air conditioning systems, boilers and heaters. Temperature monitoring and safety protection with manual reset (2 stages).

Technical data	
Sensor element	Copper bulb with 120 mm brass pocket (on request with 200 mm length)
Dimensions	108 x 70 x 72 mm (2 stage models: 132 x 88 x 70 mm)
Protection class	IP54
Ambient temperature	-35...+65 °C
Ambient humidity	10...90 % RH (non-condensing)
Storage temperature	-20...+70 °C
Storage humidity	< 95 % RH
Switch capacity	With SPDT contact: NC 250 V AC 16 (6) A / NO 250 V AC 6 (4) manual maximum reset: NC 250 V AC 16 (2,5) A / NO 250 V AC 0,5 A

Part Number	Temp. range 1	Temp. range 2	Hysteresis range 1	Hysteresis range 2	Max. bulb temp.	Function	Hidden setpoint
TV090	0...90 °C	-	4 ± 1 K	-	120 °C	with SPDT contact	-
TV090U	0...90 °C	-	4 ± 1 K	-	120 °C	with SPDT contact	X
TVR6585	65...85 °C	-	20 ± 5 K	-	125 °C	manual maximum reset*	-
TVR90110	90...110 °C	-	20 ± 5 K	-	125 °C	manual maximum reset*	-
TV09090U	0...90 °C	0...90 °C	4 ± 1 K	4 ± 1 K	120 °C	with SPDT contact	X
TV090UR85	0...90 °C	65...85 °C	4 ± 1 K	20 ± 5 K	120 °C	manual maximum reset with SPDT contact*	-

* (unit can be reset only if temperature drops below the setpoint minus the hysteresis)

ACCESSORIES

Part Number	Description
DBZ-30/14	Brass pocket 120 mm, Ø external 8 mm, Ø internal 7 mm, connection R 1/2"
DBZ-40/14	Brass pocket 108 mm, Ø external 16 mm, Ø internal 15 mm, connection R 1/2"
DBZ-31/14	Stainless steel pocket AISI 304, 120 mm, Ø external 9 mm, Ø internal 7 mm, connection R 1/2"
DBZ-41/14	Stainless steel pocket AISI 304, 120 mm, Ø external 16 mm, Ø internal 15 mm, connection R 1/2"

Note: the thermostats are supplied with standard pocket models DBZ-30/14 and DBZ-40/14.



Speak with our expert
BMS engineers today



Online training available
please speak with our team

Contact our Rol sales team on +353 (0)1 457 5421 or email sales@ibc.ie



IMMERSION THERMOSTAT, IP65

High quality immersion thermostats for use in cooling, heating and ventilation systems.

Technical data

Sensor element	Liquid-filled coiled copper bulb
Switch capacity	15 (8) A, 24...250 V AC
Dimensions	108 x 70 x 72 mm
Protection class	IP65
Ambient temperature	-35...+65 °C
Ambient humidity	10...90 % RH (non-condensing)
Storage temperature	-40...+70 °C
Storage humidity	< 95 % RH
Contacts	Microswitches with SPDT contacts (heat/cool)
Casing	Bayblend® base, ABS cover

Part Number	Temp. Range	Hysteresis	Max Bulb Temp.	Hidden Setpoint
DBTV-1	-30...+30 °C	2...20 K	60 °C	-
DBTV-2U	-30...+30 °C	1 K	60 °C	X
DBTV-7	0...+60 °C	2...20 K	75 °C	-
DBTV-7U	0...+60 °C	2...20 K	75 °C	X
DBTV-8	0...+60 °C	1 K	75 °C	-
DBTV-8U	0...+60 °C	1 K	75 °C	X
DBTV-11	50...120 °C	1 K	140 °C	-
DBTV-16	+20...+90 °C	2...20 K	100 °C	-
DBTV-17	20...90 °C	1 K	100 °C	-
DBTV-17U	20...90 °C	1 K	100 °C	X
DBTV-18	20...90 °C	manual maximum reset	100 °C	-
DBTV-18U	20...90 °C	manual maximum reset	100 °C	X



ACCESSORIES

Part Number	Description
DBZ-16/14	Brass pocket 120 mm, Ø external 10 mm, Ø internal 8,5 mm, connection R 1/2"
DBZ-17/14	Stainless steel pocket AISI 304, 120 mm, Ø external 10 mm, Ø internal 8,5 mm, connection R 1/2"

Note: The thermostats are supplied with standard pocket model DBZ-16/14. The device can only be reset if the temperature falls below the setpoint minus the hysteresis.



Large selection of Sensors in stock ready for delivery



Serving the (BMS & HVAC) Industry since 2005

RH-S - SPACE RELATIVE HUMIDITY AND TEMPERATURE SENSOR

A valuable feature of this sensor is when in 3-wire mode it automatically detects what the controller input is set to, 4-20mA or 0-10Vdc. This removes the requirement for output jumpers that can be inadvertently set incorrectly. 2-wire loop powering selectable via DIP switch. It also provides on board LED indication for power status and fault find.

FEATURES

- High stability and reliability
- Auto detection 0-10Vdc or 4-20mA outputs, loop powering via DIP
- Direct thermistor option available
- LCD display and user interface options
- Easy installation: Two part, push-in spring terminal blocks

Part Number	Description
RH-S	Space Mounted T and RH Sensor $\pm 3\%$
RH-S-EN	Space Mounted Enthalpy and Dewpoint Sensor

Part Number	Description
RH-S-AH	Space Mounted T and RH Sensor High Accuracy $\pm 2\%$

Part Number	Description
-T*	Direct resistive temperature output
-SP	11-1k Ω /0-10k Ω setpoint
-MS	Momentary switch
-LCD	Integral LCD display
-TR	Custom temperature output range
-5V	0 - 5V option
-BLK**	Black space housing

Suffixes (add to part code)

ACCESSORIES

Part Number	Description
DECOR	Decorators trim plate
GASKET	Insulating gasket (pack of 10)

Note:

1. *-T version uses a thermistor element for direct measurement of temperature. Please specify thermistor type when ordering.
2. When using the -x option, they are not compensated for internal heating.
3. Please see pages 83-85 for Thermistor Types and Compatibility Chart.
4. RH-S-EN outputs only enthalpy and dewpoint values.
5. **Plain Front, no user interface options available (SP/MS/LCD)

Sontay[®]

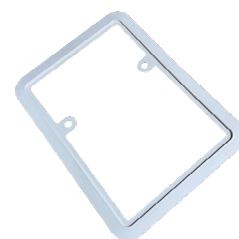

Speak with our team
about any large projects



Order before 2pm for
same day dispatch



RH - DUCT, WALL, OUTSIDE AND REMOTE PROBE RELATIVE HUMIDITY AND TEMPERATURE SENSOR

A valuable feature of this sensor is when in 3-wire mode it automatically detects what the controller input is set to, 4-20mA or 0-10Vdc. This removes the requirement for output jumpers that can be inadvertently set incorrectly. 2-wire loop powering selectable via DIP switch. It also provides on board LED indication for power status and fault find. provided.

Part Number	Description
RH-D	Duct Mounted T and RH Sensor $\pm 3\%$
RH-D-AH	Duct Mounted T and RH Sensor High Accuracy $\pm 2\%$
RH-D-EN	Duct Mounted Enthalpy and Dewpoint Sensor

Part Number	Description
RH-W	Wall Mounted T and RH Sensor $\pm 3\%$
RH-W-AH	Wall Mounted T and RH Sensor $\pm 2\%$
RH-W-EN	Wall Mounted Enthalpy and Dewpoint Sensor

Part Number	Description
RH-O	Outside Mounted T and RH Sensor $\pm 3\%$
RH-O-AH	Outside Mounted T and RH Sensor $\pm 2\%$
RH-O-EN	Outside Mounted Enthalpy & Dewpoint Sensor

Part Number	Description
RH-R	Remote probe T and RH Sensor $\pm 3\%$
RH-R-AH	Remote probe T and RH Sensor $\pm 2\%$
RH-R-EN	Remote probe Enthalpy & Dewpoint Sensor

Part Number	Description
-T*	Direct resistive temperature output
-TR	Custom temperature output range
-LCD	Integral LCD display

Suffixes (add to part code)

ACCESSORIES

Part Number	Description
-DPA	Duct probe adjustment flange (for RH-D only)

Note:

- * -T version uses a thermistor element for direct measurement of temperature. Please specify thermistor type when ordering.
- Please see pages 85-88 for Thermistor Types and Compatibility Chart.
- EN versions only output enthalpy and dewpoint values.

RH-SH - HUMIDISTATS

RH-SH humidistats are designed for the on/off control of humidification and dehumidification equipment, or the initiation of alarms or override controls.

Part Number	Description
Room Humidistats	
RH-SH-1R	Single-stage, concealed setpoint adjust.
RH-SH-1RE	Single-stage, exposed setpoint adjust.
Duct Humidistats	
RH-SH-1D	Single-stage, concealed setpoint adjust.
RH-SH-1DE	Single-stage, exposed setpoint adjust.

ST - GENERAL PURPOSE THERMOSTATS

Sontay's range of thermostats are well suited for a number of applications of temperature control or safety cut-out in pipe work systems, calorifiers, duct work systems, green houses and many other installations. They all have the set-point adjustment under the cover to prevent unauthorised tampering.

THEY ARE AVAILABLE IN TWO TYPES

Control thermostats (auto reset): With an adjustable set point, adjustable differential and auto rest, which provides a switched output to a heater or controller.

Safety thermostats (manual reset): With an adjustable set-point, fixed differential and manual reset, which provides high limit cut-out on boilers etc.

Part Number	Description	
Capillary		
ST-C-01M	50 to 140°C	Manual Reset
RH-SH-1RE	Single-stage, exposed setpoint adjust.	
Duct		
ST-D-01A	-35 to +35°C	Auto Reset
ST-D-02A	0 to 90°C	Auto Reset
ST-D-03A	-30 to +30°C	Auto Reset
ST-D-04M	0 to +90°C	Manual Reset
Immersion		
ST-I-01A	0 to 120°C	Auto Reset
ST-I-02M	0 to 110°C	Manual Reset
ST-I-03M	20 to 90°C	Manual Reset
Wall		
ST-W-01A	-30 to +30°C	Auto Reset
Strap-on		
ST-S-02A	0 to 90°C	Auto Reset

ACCESSORIES

Part Number	Description
ST-IMM-PKT	Replacement stainless steel pocket (ST-I range only)

Sontay®





ST-FRE - CAPILLARY FROST THERMOSTATS

The ST-FRE range of frost thermostats provide a switch output based on the average temperature detected along a two or six metre capillary sensor. A common application is for frost protection on fresh air intakes or airconditioning systems, to prevent the icing up of filters, fans and coils. The capillary is fixed in a matrix across

Part Number	Description
IP44 Thermostat	
ST-FRE-1	Auto reset, 6m capillary, Frost Thermostat
ST-FRE-2	Manual reset, 6m capillary, Frost Thermostat
ST-FRE-3	Auto reset, 2m capillary, Frost Thermostat
ST-FRE-4	Manual reset, 2m capillary, Frost Thermostat

Part Number	Description
IP65 Housing and Thermostat	
ST-FRE-1-IP65	Auto reset, 6m capillary, Frost Thermostat
ST-FRE-2-IP65	Manual reset, 6m capillary, Frost Thermostat
ST-FRE-3-IP65	Auto reset, 2m capillary, Frost Thermostat
ST-FRE-4-IP65	Manual reset, 2m capillary, Frost Thermostat

ACCESSORIES

Part Number	Description
ST-DFK	Pack of six additional plastic capillary fixing clips
BRK	Mounting bracket for ST-FREx

ST-TY - SPACE THERMOSTATS

The ST-TY series of wall mounting space thermostats are suitable for heating and/or cooling and frost protection applications.

Part Number	Description	Range
ST-TY92-C1	Heating Thermostat	5 to 35°C
ST-TY92-C1F	Frost Thermostat	-5 to +15°C
ST-TY92-C3	Heating or Cooling Thermostat	5 to 35°C
ST-TY92-C3T	Heating or Cooling Tamperproof	5 to 35°C



Speak with our team
about any large projects



Order before 2pm for
same day dispatch

TT-518 - THIMBLE SENSORS

Thimble temperature sensors are used for measuring air temperature in indoor spaces. The sensing element is mounted in an attractive 'thimble' enclosure for surface mounting, typically on a backplate or a ceiling tile.

Part Number	Description
Passive Output	
TT-518-A	10K3A1, Trend, Cylon, Distech, Heatmiser
TT-518-C	20K6A1, Honeywell
TT-518-M	2.2K3A1, Johnson Controls
Active Output	
TT-518-CVO	Selectable: 4-20mA/0-10Vdc * Output ranges: -10 to +40°C or -10 to +110°C (selectable)
TT-518-CVO-C	Selectable: 4-20mA/0-10Vdc (custom temp, scaling) *, Scaled to customer specification in the range of -10 to +60°C

Compatibility with other manufacturers is available

Part Number	Description
-AL	Aluminium thimble
-SS	Stainless steel thimble
-BLK	Black Thimble
-BR	Brass thimble
-5M	5m cable length
-LSZH	Low Smoke Zero Halogen option

Suffixes (add to part code)

Note:

* These units are supplied with the transmitter in the plant housing.

UI-500 - INTERFACE OPTIONS

INDIVIDUAL SOLUTIONS

In addition to our standard range of sensors we are able to manufacture user interface equipment to your specifications. Typically this would be a single or twin gang plate styled to match other equipment on a project. We can fit a large range of devices to UI-500 products including sensors, setpoint adjustments and LCDs.

UI-AA-I-F - ALARM ANNUNCIATORS

The UI-AA-I-F is used in conjunction with one analogue or VFC signals to provide local audible and visual alarm facilities.

Part Number	Description
UI-AA-1-F	1-channel Interface Panel

Sontay[®]



Speak with our expert
BMS engineers today



Online training available
please speak with our team



TT-D - DUCT SENSORS

The TT-D are used to measure air temperature in ducts. The sensing element is fitted into a stainless steel probe. A flange plate is available for adjustment of penetration depth (order as TT-DFP).

Part Number	Description
Passive Output	
TT-D-A	10K3A1, Trend, Cylon, Distech
TT-D-C	20K6A1, Honeywell
TT-D-M	2.2K3A1, Johnson Controls
Active Output	
TT-D-CVO	Selectable: 4-20mA/0-10Vdc Output ranges: -10 to +40°C or -10 to +110°C (selectable)
TT-D-CVO-C	Selectable: 4-20mA/0-10Vdc (custom temp. scaling), Scaled to customer specification in the range of -10 to +100°C

Compatibility with other manufacturers is available

ACCESSORIES

Part Number	Description
TT-DFP	Duct flange plate

Part Number	Description
-65	65mm Probe length
-250	250mm Probe length

Suffixes (add to part code)

TT-DA - DUCT AVERAGING SENSORS

The TT-DA temperature sensors are used for measuring temperature in ducts where an average reading across the air flow is required. Sensing elements are housed in a nylon tube, and spaced at intervals along the standard 2.2m length.

Part Number	Description
Passive Output	
TT-DA-A	10K3A1, Trend, Cylon, Distech
TT-DA-C	20K6A1, Honeywell
TT-DA-G	Ni1000A/TCR (LAN1), Siemens
TT-DA-M	2.2K3A1, Johnson Controls
Active Output	
TT-DA-CVO	Selectable: 4-20mA/0-10Vdc Output ranges: -10 to +40°C or -10 to +110°C - selectable
TT-DA-CVO-C	Selectable: 4-20mA/0-10Vdc (custom temp. scaling), Scaled to customer specification in the range of -10 to +100°C

Compatibility with other manufacturers is available

Part Number	Description
-5M	5m cable length

Suffixes (add to part code)

TT-O - OUTSIDE AIR SENSORS

The TT-O range are use for measuring outside air temperature. The sensors are housed in IP65 rated enclosures. The TT-O should always be situated in a sheltered position on a north facing wall.

Part Number	Description
Passive Output	
TT-O-A	10K3A1, Trend, Cylon, Distech
TT-O-C	20K6A1, Honeywell

Compatibility with other manufacturers is available

TT-OR - OUTSIDE AIR SENSORS WITH RADIATION SHIELD

The TT-OR has the element fitted into a PTFE radiation shield, designed to provide fast response times to changes in outside air temperature and to protect the element from the effects of direct sunlight.

Part Number	Description
Passive Output	
TT-OR-A	10K3A1, Trend, Cylon, Distech
TT-OR-C	20K6A1, Honeywell

Compatibility with other manufacturers is available

TT-I - IMMERSION SENSORS

Immersion sensors are used for measuring the temperature of liquids in pipework. The sensing element is housed in a stainless steel probe fitted to an IP65 rated enclosure, for direct mounting into TT-PO-521 or TT-PO-HP range of stainless steel pockets

Part Number	Description
Passive Output	
TT-I-A	10K3A1, Trend, Cylon, Distech
TT-I-C	20K6A1, Honeywell

Compatibility with other manufacturers is available

Part Number	Description
-65	65mm probe length
-100	100mm probe length
-250	250mm probe length

Suffixes (add to part code)

Sontay®



Speak with our expert
BMS engineers today



Online training available
please speak with our team



TT-C - CLAMP-ON SENSORS

The TT-C is used to measure pipe temperature, the sensor is housed in a 50mm long probe with two METERS of PTFE 2-core cable as standard connecting the probe to an IP65 housing for termination.

Part Number	Description
Passive Output	
TT-C-A	10K3A1, Trend, Cylon, Distech
TT-C-C	20K6A1, Honeywell

Compatibility with other manufacturers is available

ACCESSORIES

Part Number	Description
BAND	Additional Metal Band

Part Number	Description
-5M	5m cable length

Suffixes (add to part code)

TT-555 - FLYING LEAD SENSORS

The TT-555 is used to measure air temperature in fan-coil units as well as many other applications. The standard cable length is two metres of 2-core screened cable with a 5 meter option. Longer lengths can be made to order.



Part Number	Description
Passive Output	
TT-555-A	10K3A1, Trend, Cylon, Distech
TT-555-C	20K6A1, Honeywell
TT-555-M	2.2K3A1, Johnson Controls
Active Output	
TT-555-CVO	Selectable: 4-20mA/0-10Vdc * Output ranges: -10 to +40°C or -10 to +110°C (selectable)
TT-555-CVO-C	Selectable: 4-20mA/0-10Vdc (custom temp. scaling) *, Calibration to customer specification in the range of -10 to +60°C

* These units are supplied with the transmitter in the plant housing.

Compatibility with other manufacturers is available

Part Number	Description
-5M	5m cable length
-LSZH	Low Smoke Zero Halogen option
-R	Cap potted (waterproof)

Suffixes (add to part code)

TT-CD - DIRECT CLAMP-ON SENSORS

The TT-CD clamp-on sensor is used for direct connection to measure pipe temperature. The sensing element is enclosed in a moulded nickel contact bar on the underside of the main housing.

Part Number	Description
Passive Output	
TT-CD-A	10K3A1, Trend, Cylon, Distech
Active Output	
TT-CD-CVO	Selectable: 4-20mA/0-10Vdc Output ranges: -10 to +40°C or -10 to +110°C (selectable)
TT-CD-CVO-C	Selectable: 4-20mA/0-10Vdc (custom temp. scaling), Calibration to customer specification in the range of -10 to +100°C

Compatibility with other manufacturers is available

ACCESSORIES

Part Number	Description
BAND	Additional Metal Band

TT-S - SPACE SENSOR

This range of innovative space sensors is designed to meet the exacting standards of today's architects, specifiers and building owners.

Part Number	Description
Passive Output	
TT-S-A	10K3A1, Trend, Cylon, Distech
Active Output	
TT-S-ACT	Selectable: 4-20mA/0-10Vdc, output range 0 to 40°C
TT-S-ACT-TR	Selectable: 4-20mA/0-10Vdc, custom temp. scaling between -10 to +50°C

Compatibility with other manufacturers is available

Part Number	Description
-SP	2-wire, 11-1kΩ/0-10Ω setpoint
-MS	Momentary switch
-LCD *	Integral display
-LEDG **	24V Green LED
-BLK ***	Black housing

Suffixes (add to part code)

* Only available on -ACT types

** Not available on -ACT types

*** Plain front, no user interface options available (SP/MS/LCD/LEDG)

ACCESSORIES

Part Number	Description
DECOR	Decorators trim plate
GASKET	Insulating gasket (pack of 10)

Sontay®

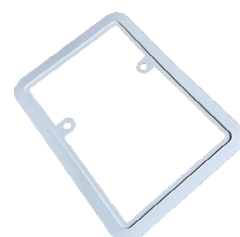



TT-BB - BLACK BULB SENSOR

Comfort temperature measurement can be best achieved by taking into account the radiant effect of surfaces within the controlled space. The comfort temperature is specified as the average of the conductive temperature and the radiant temperature.

Part Number	Description
Passive Output	
TT-BB-A	10K3A1, Trend, Cylon, Distech

Compatibility with other manufacturers is available

Part Number	Description
-SP	2-wire, 11-1k Ω /0-10 Ω setpoint
-MS	Momentary switch
-LEDG	24V Green LED
-BLK *	Black housing

Suffixes (add to part code)

* Plain front, no user interface available (SP/MS/LCD/LEDG)

ACCESSORIES

Part Number	Description
DECOR	Decorators trim plate
GASKET	Insulating gasket (pack of 10)

TT-CAL - CALIBRATION

In house calibration is available for Sontay's RH range of sensors using our state of the art environmental chamber. Sontay can provide test certificates for 3-point calibration, with additional points if required -CVO & -ACT types ONLY.

Part Number	Description
TT-CAL	3-Point calibration at 15, 25 & 35°C
TT-CAL-ADP	Additional calibration point, select between 0 & 70°C

TT-PO - IMMERSION SENSOR POCKETS

POCKETS THAT CAN WITHSTAND HIGHER PRESSURES AND FLOW RATES

TT-PO-521 and TT-PO-HP range of stainless steel pockets are for use with immersion sensors TT-I and TT-IH. The two part welded TT-PO-521 pockets are intended for low flow applications. They may be used in applications such as sumps or storage tanks or low flowing water in pipes.

For applications requiring installation in high flowing water, the TT-PO-HP should be used.

Part Number	Description	
TT-PO-521-65	Stainless Steel Immersion Pocket	65mm Pockets
TT-PO-521-100	Stainless Steel Immersion Pocket	100mm Pockets
TT-PO-521	Stainless Steel Immersion Pocket	150mm Pockets
TT-PO-HP	High Performance Stainless Steel Immersion Pocket	
TT-PO-521-250	Stainless Steel Immersion Pocket	250mm Pockets
TT-PO-HP-250	High Performance Stainless Steel Immersion Pocket	250mm Pockets

IMMERSION TEMPERATURE SENSORS

A direct output temperature sensor used for measuring liquid temperature in pipes.

Part Number	Description
IBC-TB/TI-S	Trend/Honeywell/Thorn/New Cylon Systems 10k3a1
IBC-TT-PO-521	With Pocket

Compatibility with other manufacturers is available

DUCT TEMPERATURE SENSORS

A direct output temperature sensor used for measuring air temperature in ducts.

Part Number	Description
IBC-TB/TI-S	Trend/Honeywell/Thorn/New Cylon Systems 10k3a1

Compatibility with other manufacturers is available

OUTSIDE TEMPERATURE SENSORS

A direct output temperature sensor used for measuring air temperature in ducts.

Part Number	Description
IBC-TB/TO	Trend/Honeywell/Thorn/New Cylon Systems 10k3a1

Compatibility with other manufacturers is available

CLAMP-ON TEMPERATURE SENSORS

A direct output temperature sensor used for measuring pipe temperature.

Part Number	Description
IBC-TB/TC	Trend/Honeywell/Thorn/New Cylon Systems 10k3a1

Compatibility with other manufacturers is available

FLYING LEAD TEMPERATURE SENSORS

A low cost direct output temperature sensor used for measuring air temperature, i.e. in fan-coil units etc.

Part Number	Description
IBC-TF	Trend/Honeywell/Thorn/New Cylon Systems Standard 2m Version 10k3a1

Compatibility with other manufacturers is available

ROOM/SPACE TEMP. SENSOR

A direct output temperature sensor used for measuring air temperature in indoor spaces.

Part Number	Description
IBC-TB/TS	Trend/Honeywell/Thorn/New Cylon Systems 10k3a1

Compatibility with other manufacturers is available



AXIO



ACTIVE TEMPERATURE SENSORS

The AX-TE-xTX-W range of active temperature sensors. Offering an advanced, versatile method for the monitoring of temperature, in a variety of applications.

Jumper selectable output ranges cover an incredible -50°C to +400°C and the unit offers both 0-10V & loop powered 4-20mA output in the same unit.

Part Number	Description
AX-TE-DTX-W	Duct - 150mm Probe
AX-TE-FTX-W	Flying Lead Active Sensor
AX-TE-ITX-W	Immersion - 150mm Probe
AX-TE-ITX-W-65	Immersion - 65mm Probe
AX-TE-OTX-W	Outside Air
AX-TE-RTX-W	Room
AX-TE-STX-W	Pipe Strap - 2 Meter

RH & T TRANSMITTERS

The AX-RHT-3 range of RH&T Transmitters are designed for high accuracy relative humidity and temperature measurement, having selectable analogue output of both values.

Part Number	Description
AX-RHT-S	Room version 2.5% Acc
AX-RHT-D3	Duct version 3% acc
AX-RHT-O3	Outside version 3% acc
AX-RHT-S2	Room version 2% acc
AX-RHT-D2	Duct version 2% acc
AX-RHT-O2	Outside version 2% acc
AX-RHT-SD	Room version 2.5% Acc c/w display

Thermistor type version also available on request

ALCO FROST THERMOSTATS

Frost thermostat with 6 metre capillary sensor. Application for frost protection for example on air-conditioning systems to prevent the build up of ice on filters, fans and coils etc.

Part Number	Description
TSA-A2P	Auto reset
TSA-R2P	Manual reset



Speak with our team
about any large projects



Order before 2pm for
same day dispatch

ALRE RANGE. 15AMP RATED SPDT. IP43 PROTECTION AUTO RESET SINGLE THERMOSTAT AUTO RESET

In heating technology this unit is used in boiler systems or in thermal accumulators, heating transfer stations and heating transfer systems. Used in ventilation technology as for monitoring supply air or as a limiter in electrical heating registers.

Part Number	Range (°C)	Diff (°C)	Length (mm)
RTKSA-001-100	0-50	1.3	120
RTKSA-001-200	0-120	3	100
RTKSA-001-301	20-150	3.3	100

NOTE: thermostats as standard complete with pocket. Stainless steel available on request.

ALRE RANGE. 15AMP RATED SPDT. IP43 PROTECTION SINGLE THERMOSTAT MANUAL RESET

In heating technology this unit is used in boiler systems or in thermal accumulators, heating transfer stations and heating transfer systems. Used in ventilation technology as for monitoring supply air or as a limiter in electrical heating registers.

Part Number	Range (°C)	Length (mm)
RTKSA-002-410	30-110	100

ALRE RANGE. 15AMP RATED SPDT. IP43 PROTECTION DUAL THERMOSTAT

In heating technology this unit is used in boiler systems or thermal accumulator systems, heating transfer stations and heating transfer systems.

Part Number	Range (°C)	Limit (°C)	Reset
RTKSA 014-210	0-120	0-120	Thermal
RTKSA 013-210	0-120	20-150	Hand

alre



Accurate and Reliable Airflow measurement for your demanding HVAC applications



Airflow measurement is not a one size fits all application, your solution for accurate and reliable airflow measurement shouldn't be either.

- Field Characterization
- Zero Calibration Function
- Robust Sensor Design

ELECTRA-flo 5 Series
Thermal Airflow Measurement System



OAM II
Outdoor Airflow Measurement System & Airflow Station



VOLU-probe and Veltron transmitter
Pitot Airflow Measurement System



Learn more about our products
AIRMONITOR.COM/HVAC • 800-AIR-FLOW

Represented locally by





Light & Occupancy

LL - LIGHT LEVEL SENSORS

Our range of light level sensors output a linear 0-10Vdc signal representing the lux level at the sensor element. This is typically used in lighting strategies to optimise energy efficiency through dimming and/or disabling of lights as required.

The LL-P-V has two selectable ranges of 10 to 2000 and 10 to 10,000. The LL-C-V has a fixed range of 10 to 2000 lux.

Part Number	Description
LL-P-V	External Light Level Sensor

Technical data

Sensor reference	Photo-diode
Accuracy	±5% across range
Ranges (selectable)	0 to 2000 Lux 10 to 10,000 Lux
Output	0-10Vdc
Supply	24Vac/dc
Dimensions	125 x 105 x 85mm
Protection	IP65

Part Number	Description
LL-C-V	Ceiling Mounted Internal, Light Level Sensor

Technical data

Sensor reference	Photo-diode
Accuracy	±5% across range
Ranges (selectable)	10 to 2000 Lux
Output	0-10Vdc
Supply	24Vac/dc
Dimensions	76mm (dia.) x 95mm (H)
Protection	IP30

LL-C-M - LIGHTING AND OCCUPANCY CONTROLLER

Designed to give savings over uncontrolled lighting. A passive infra-red detector monitors occupancy through moving body heat and a photosensitive device monitors light level. This will ensure that lighting is only switched on when the area covered is occupied and the light level is too low for normal working conditions.

Part Number	Description
LL-C-M	230Vac. flush ceiling mounted light level and occupancy controller

OC - OCCUPANCY DETECTORS

Using passive infra-red detection, the OC-x-LV range of occupancy detectors monitors occupation through moving body heat which activates the internal SPDT relay.

The OC-C-LVN is for flush mounting through a false ceiling using the clips provide. An LED indicates detection, this flashes every 2 seconds on detection. The LED will be off when no occupancy is detected.

Part Number	Description
OC-C-LVN	Ceiling Mounted, PIR Occupancy Detector

The OC-W-LV can be directly fixed to a wall or mounted using the angled bracket supplied.

Part Number	Description
OC-W-LV	Wall Mounted, PIR Occupancy Detector

The OC-C-M is an active motion detector for direct ceiling mounting. It emits high-frequency electro-magnetic wave (5.8GHz). It detects the change in echo from even the slightest movement in its detection zone.

Part Number	Description
OC-C-M	Ceiling Mounted, Microwave Occupancy Detector

LIGHT LEVEL AND OCCUPANCY DETECTORS

A range of low cost Light Level and Occupancy Sensors for surface, flush and wall mounting. There are switched live and volt free output variants the light level can be switched off if required. Mains and low voltage variants.

Part Number	Description
AX-OCF-230F	Switched live output, 230v, flush mounted
AX-OCF-230S	Switched live output, 230v, surface mounted
AX-OCF-230W	Switched live output, 230v, wall mounted
AX-OCF-230-FVF	VFC output, 230v, flush mounted
AX-OCF-230-SVF	VFC output, 230v, surface mounted
AX-OCF-24-FVF	VFC output, 24v, flush mounted
AX-OCF-24-SVF	VFC output, 24v, surface mounted

Sontay[®]



AXIO



Speak with our team
about any large projects



Order before 2pm for
same day dispatch



Air Pressure & Velocity

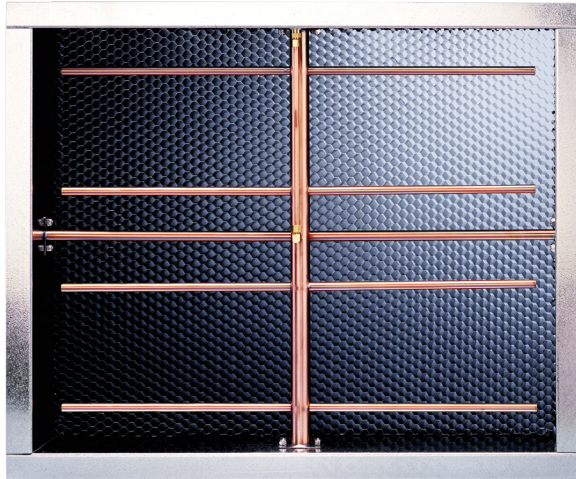

FAN-EVALUATOR Airflow Measuring Station

The FAN-E is a multi-point, self-averaging Pitot traverse station with integral air straightener-equalizer honeycomb cell, capable of continuously measuring fan discharges or ducted airflow with an accuracy of 2% or better.

The FAN-E derives its high degree of measurement accuracy from a combination of precision sensor locations, honeycomb airflow processing, pneumatic averaging of a large number of sensed airflow pressures, and patented "symmetrical averaging" (Patent No. 3,685,355), which requires that all stages in the averaging process occur at a point where there is a balanced array of sensors present, thereby assuring that each sensed pressure is given the same "equal weight" in the averaging process as other sensed pressures.



S.O.A.P. Static Outside Air Probe

To optimize the performance of the S.O.A.P., it must be located away from all structures and obstacles of sufficient size to create a wind induced pressure envelope. Typical locations are on an elevated position in an outdoor parking lot, in a below ground recess (landscaped or lawn area), away from buildings, in a below ground location like a parking garage with non-forced ventilation, or on a rooftop mounted pole sufficiently elevated to be outside any anticipated wind induced pressure envelope.

The perforations located on the entering air edges of the parallel plates act as a means of diffusing the entering airflow to minimize the effect of non-horizontal flow on the sensor performance, thereby permitting entry flows with approach angles up to 60° from the horizontal without affecting the accuracy of the pressure measurement. The perforations located near the center of the bottom plate opposite the signal connection serve to relieve the venturi effect that will develop with higher airflow rates (winds) through parallel plates, thereby permitting non-pulsating sensing in the presence of high wind gusts.

Accurate airflow measurement
for demanding applications



Speak with our team about any bespoke requirements from Air Monitor

AV - MULTI-POINT AIR VELOCITY PROBES

The AV-EP and the AV-MPS velocity probes are used to ensure that recommended flow rates for public buildings and industrial plants are achieved. They are used with either the PA-DPT, PA-65x, PA-699 or PA-267 Air Differential Pressure Sensor of an appropriate range.

Part Number	Description
AV-EP-100	100mm - Multi-point Probe (ABS)
AV-EP-200	200mm Multi-point Probe (ABS)
AV-EP-300	300mm Multi-point Probe (ABS)
AV-EP-400	400mm Multi-point Probe (ABS)
AV-EP-500	500mm Multi-point Probe (ABS)
AV-EP-600	600mm Multi-point Probe (ABS)
AV-MPS-700	To suit duct size of 600-700mm
AV-MPS-800	To suit duct size of 700-800mm
AV-MPS-1000	To suit duct size of 750-1000mm
AV-MPS-1250	To suit duct size of 1000-1250mm

PA-699 - MULTI-RANGE AIR DP SENSOR

Sontay's range of field selectable multi-range differential pressure transmitters, incorporate a proven ceramic fulcrum lever technology for pressure measurement. The PA-699 has three field selectable ranges in one unit, providing versatility for a multitude of applications.

Part Number	Description
PA-699-01	± 30 , ± 50 & ± 100 Pa, 4-20mA Multi Range, Bi-directional
PA-699-02	0 to 30, 50, 100Pa, 4-20mA Multi Range
PA-699-04	0 to 100, 300, 500Pa, 4-20mA Multi Range
PA-699-06	0 to 500, 1000, 1600Pa, 4-20mA Multi Range
PA-699-08	0 to 1600, 2500, 5000Pa, 4-20mA Multi Range

ACCESSORIES

Part Number	Description
DFK	Duct fixing kit
TEE	Tee piece air pressure (pack of 10)
PITOT	Aluminum Pitot Tubes (Pair)
PA-TUBE-CLEAR	PVC tube 8mm o/d x 1.5mm wall, 30m reel
PA-TUBE-RED	Red PVC tube 8mm o/d x 1.5mm wall, 30m reel
PA-TUBE-BLUE	Blue PVC tube 8mm o/d x 1.5mm wall, 30m reel
PA-BRK	DIN-rail bracket
PA-699-CAL *	Calibration certificate

* This option must be specified at time of sensor order. They are built to order and not available ex-stock.

Part Number	Description
-V	0-10V voltage output
-LCD	Integral LCD option

Suffixes (add to part code)





PA-DPT - MULTI-RANGE AIR DIFFERENTIAL PRESSURE TRANSMITTER

The PA-DPT differential pressure transmitter is ideal for measuring filter conditions, as well as many other applications in ventilation/air conditioning systems in buildings, laboratory's and clean rooms (air and non-corrosive gases). Featuring field-selectable output signals (3-wire 4-20mA, 0-10Vdc or 2-10Vdc) and 8 pressure ranges, unidirectional or bi-directional via jumpers. An optional LCD display is also available.

Part Number	Description
PA-DPT-01	±30, ±50 & ±100Pa, 4-20mA Multi Range, Bi-directional
PA-DPT-01-HA	0 to 30, 50, 100Pa, 4-20mA Multi Range
PA-DPT-02	0 to 100, 300, 500Pa, 4-20mA Multi Range

Part Number	Description
-LCD	Integral LCD display

Suffixes (add to part code)

PA-65 - MULTI-CONFIGURABLE AIR DP SENSOR

The PA-65-x pressure transducers sense differential or gauge (static) pressure and convert this pressure difference to a proportional electrical output for either field selectable unidirectional or bi-directional pressure ranges. The PA-65-x series is offered with field selectable ranges and analogue outputs of 0 to 5Vdc, 0 to 10Vdc, or 4 to 20mA.



Part Number	Description
PA-65-0	0 to 50, 100, 150, 200Pa bi-directional ±50, ±100, ±150, ±200Pa
PA-65-1	0 to 250, 500, 750, 1000Pa bi-directional ±250, ±500, ±750, ±1000Pa
PA-65-2	0 to 750, 1500, 2250, 3000Pa bi-directional ±750, ±1500, ±2250, ±3000Pa

Part Number	Description
-CL	Clear Lid (LCD visible)
-S	Static pressure probe

Suffixes (add to part code)

ACCESSORIES FOR BOTH PA-DPT & PA-65

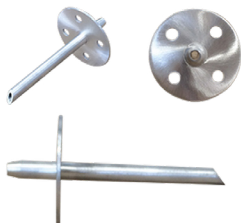

Part Number	Description
DFK	Duct fixing kit
TEE	Tee piece air pressure (pack of 10)
PITOT	Aluminum Pitot Tubes (Pair)
PA-TUBE-CLEAR	PVC tube 8mm o/d x 1.5mm wall, 30m reel

NOTES: A duct fixing kit (DFK) is supplied with the sensor, consisting of 2m of 5mm i/d plastic tubing, 2 x pitot tubes and 4 x fixing screws.

PA-267 - AIR DP SENSORS

The PA-DPT differential pressure transmitter is ideal for measuring filter conditions, as well as many other applications in ventilation/air conditioning systems in buildings, laboratory's and clean rooms (air and non-corrosive gases). Featuring field-selectable output signals (3-wire 4-20mA, 0-10Vdc or 2-10Vdc) and 8 pressure ranges, unidirectional or bi-directional via jumpers. An optional LCD display is also available. Sensor types 01 & 02 have manual re-zero facility whereas the 01-HA version has an auto zero function for automatic zero point calibration making it a virtually maintenance free sensor.

Part Number	Description
PA-267-25	0 to 25Pa 4-20mA Transmitter
PA-267-50	0 to 50Pa 4-20mA Transmitter
PA-267-100	0 to 100Pa 4-20mA Transmitter
PA-267-300	0 to 300Pa 4-20mA Transmitter
PA-267-500	0 to 500Pa 4-20mA Transmitter
PA-267-1000	0 to 1000Pa 4-20mA Transmitter
PA-267-1600	0 to 1600Pa 4-20mA Transmitter
PA-267-2500	0 to 2500Pa 4-20mA Transmitter
PA-267-3000	0 to 3000Pa 4-20mA Transmitter

ACCESSORIES

Part Number	Description
DFK	Duct fixing kit
TEE	Tee piece air pressure (pack of 10)
PITOT	Aluminum Pitot Tubes (Pair)
PA-TUBE-CLEAR	PVC tube 8mm o/d x 1.5mm wall, 30m reel
PA-TUBE-RED	Red PVC tube 8mm o/d x 1.5mm wall, 30m reel
PA-TUBE-BLUE	Blue PVC tube 8mm o/d x 1.5mm wall, 30m reel
PA-267-CAL *	Calibration certificate

Part Number	Description
-V	0-10V voltage output
-B	Bi-directional
-AH	High accuracy
-LCD *	Integral LCD display

Suffixes (add to part code)

* These options must be specified at time of sensor order. A duct fixing kit (DFK) is supplied with the sensor, consisting of 2m, 5mm i/d plastic tubing, 2 x pitot tubes and 4 x fixing screws.

Sontay[®]



Speak with our expert
BMS engineers today



Online training available
please speak with our team



PA-DPS - AIR DP SWITCH

These are highly sensitive air differential pressure switches, suitable for providing an indication of fan status and 'dirty filter' conditions. The switching setpoint is adjusted by means of a knob mounted under the main cover. Units are supplied complete with a duct fixing kit.

Part Number	Description	
IP54 Housing		
PA-DPS-88	0 to 25Pa	4-20mA Transmitter
PA-DPS-83	0 to 50Pa	4-20mA Transmitter
PA-DPS-85	0 to 100Pa	4-20mA Transmitter
PA-DPS-90	0 to 300Pa	4-20mA Transmitter
PA-DPS-91	0 to 500Pa	4-20mA Transmitter
PA-DPS-92	0 to 1000Pa	4-20mA Transmitter

ACCESSORIES

Part Number	Description
PA-DPS-B	Right angled mount bracket (PA-DPS-88 only)

Part Number	Description	
IP65 Housing		
PA-DPS-90W	0 to 25Pa	4-20mA Transmitter
PA-DPS-91W	0 to 50Pa	4-20mA Transmitter
PA-DPS-92W	0 to 100Pa	4-20mA Transmitter
PA-DPS-94W	0 to 300Pa	4-20mA Transmitter

ACCESSORIES

Part Number	Description
DFK	Duct fixing kit
TEE	Tee piece air pressure (pack of 10)
PITOT	Aluminum Pitot Tubes (Pair)
PA-TUBE-CLEAR	PVC tube 8mm o/d x 1.5mm wall, 30m reel
PA-TUBE-RED	Red PVC tube 8mm o/d x 1.5mm wall, 30m reel
PA-TUBE-BLUE	Blue PVC tube 8mm o/d x 1.5mm wall, 30m reel

NOTE: A duct fixing kit (DFK) is supplied with the switch, consisting of 2m of 5mm i/d plastic tubing, 2 x pitot tubes and 4 x fixing screws.



Speak with our team
about any large projects



Order before 2pm for
same day dispatch

Liquid Level, Flow & Pressure

PL-PSA - LIQUID PRESSURE SWITCH

Adjustable pressure switches, suitable for the monitoring of flow failure and proving in pumps, chillers, valves etc. Units have an adjustable setpoint and differential.

Part Number	Description
PL-PSA-1	-0.75 to +3 bar
PL-PSA-2	-0.8 to +1.5 bar
PL-PSA-3	-0.5 to +7 bar

ACCESSORIES

Part Number	Description
PL-PIG	2m of 6mm copper tubing + fitting
BRK	Bracket for PL-PSAx

PL-FD113 - LIQUID DP SWITCH

Liquid differential pressure switch suitable for monitoring flow status across pumps, chillers, valves etc. The switch has an adjustable set point from 0.3 to 4.5 bar with a fixed differential of 0.2 bar.

Part Number	Description
PL-FD113	0.3 to 4.5 bar Liquid DP Switch

ACCESSORIES

Part Number	Description
PL-FD113-PIG	Connection Kit

NOTE:

A mounting bracket is supplied with the switch. The PL-FD113-PIG consist at 2m of 6mm copper tubing and 4 x compression fittings (¼")

Sontay[®]





ONICON
Flow and Energy Measurement

Need To Monitor Flow But unable to shut your system down?





ONICON offers a variety of insertion style meters that can be hot-tapped and inserted in a *live* system. From chilled water to steam, we have the right meter for your application.

onicon.com



PL-52X - STATIC PRESSURE SENSORS

The PL-525 static pressure sensors are suitable for use with a large range of liquids and gases compatible with the FPM (Viton) seal. The pressure transmitter is based on proven ceramic technology for exceptional performance speed and reliability. PL-520 pressure sensor is based upon thick film technology where the pressure cell is fully welded. This sensor meets the high burst protection demands and is suitable for a wide range of applications.

FEATURES

- Compact rugged construction
- Negligible temperature influence on accuracy
- IP65 protection
- Electrical terminals and gland to DIN EN175 301-803-A
- Supply short circuit & polarity reversal protection

Part Number	Description	
4-20mA Output (2-wire loop powered)		
PL-525-0.1	0 to 100 mbar	Low Pressure
PL-525-0.2	0 to 200 mbar	
PL-525-0.3	0 to 300 mbar	
PL-525-0.6	0 to 600 mbar	
PL-520-1	0 to 1 bar	
PL-520-1.6	0 to 1.6 bar	
PL-520-2.5	0 to 2.5 bar	
PL-520-4	0 to 4 bar	
PL-520-6	0 to 6 bar	
PL-520-10	0 to 10 bar	
PL-520-16	0 to 16 bar	
PL-520-25	0 to 25 bar	
PL-520-40	0 to 40 bar	

Part Number	Description	
0-10Vdc Output		
PL-525-0.1-V	0 to 100 mbar	Low Pressure
PL-525-0.2-V	0 to 200 mbar	
PL-525-0.3-V	0 to 300 mbar	
PL-525-0.6-V	0 to 600 mbar	
PL-520-1-V	0 to 1 bar	
PL-520-1.6-V	0 to 1.6 bar	
PL-520-2.5-V	0 to 2.5 bar	
PL-520-4-V	0 to 4 bar	
PL-520-6-V	0 to 6 bar	
PL-520-10-V	0 to 10 bar	
PL-520-16-V	0 to 16 bar	
PL-520-25-V	0 to 25 bar	
PL-520-40-V	0 to 40 bar	

ACCESSORIES

Part Number	Description
PL-HS	Pressure Transmitter Heat Sink
PL-525-CAL *	Calibration certificate
PL-520-CAL *	Calibration certificate

NOTE:

1. Heat Sink PL-HS can be used where media has a higher temperature than the sensor allows.
2. *This option must be specified at the time of sensor order. It is built to order and not available ex-stock.



Speak with our expert
BMS engineers today



Online training available
please speak with our team

PL-630-A - DIFFERENTIAL PRESSURE SWITCH

Ideal for flow monitoring and proving applications in heating, ventilating and air-conditioning systems.

Part Number	Description
PL-630-A-0.02	6 to 20 mbar Liquid DP Switch
PL-630-A-0.06	15 to 60 mbar Liquid DP Switch
PL-630-A-0.2	40 to 200 mbar Liquid DP Switch
PL-630-A-1	0.15 to 1 bar Liquid DP Switch
PL-630-A-3	1 to 3 bar Liquid DP Switch
PL-630-A-5.5	2 to 5.5 bar Liquid DP Switch

ACCESSORIES

Part Number	Description
PL-630-PIG	Connection Kit

NOTE: The PL-630-PIG consist at 2m of 6mm copper tubing and 4 x compression fittings (2x1/8" + 2x3/4")

PL-692 - DIFFERENTIAL PRESSURE SENSOR

For high accuracy and close control applications, the PL-692 features ceramic sensing technology for exceptional accuracy and reliability. The amplified sensing technologies allow high temperature stability and no creepage associated with mechanical systems.

Part Number	Part Number	Description
4-20mA Output (2-wire loop powered)	0-10Vdc Output	
PL-692-0.1	PL-692-0.1-V	0 to 100 mbar Liquid DP Sensor
PL-692-0.2	PL-692-0.2-V	0 to 200 mbar Liquid DP Sensor
PL-692-0.4	PL-692-0.4-V	0 to 400 mbar Liquid DP Sensor
PL-692-1	PL-692-1-V	0 to 1 bar Liquid DP Sensor
PL-692-2.5	PL-692-2.5-V	0 to 2.5 bar Liquid DP Sensor
PL-692-4	PL-692-4-V	0 to 4 bar Liquid DP Sensor
PL-692-6	PL-692-6-V	0 to 6 bar Liquid DP Sensor
PL-692-10	PL-692-10-V	0 to 10 bar Liquid DP Sensor
PL-692-16	PL-692-16-V	0 to 16 bar Liquid DP Sensor

ACCESSORIES

Part Number	Part Number	Description
PL-692-CAL *		Calibration certificate

NOTE: A mounting bracket is supplied with the sensor.

* This option must be specified at the time of sensor order. It is built to order and not available ex-stock.

Sontay®



IBC stock over 2500 products
ready for immediate delivery



Serving the (BMS & HVAC)
Industry since 2005



LS-CAP - CAPACITANCE LEVEL SENSORS

These sensors are designed for level measurement in tanks or sumps providing a 4-20mA output relating to the level of fluid in the tank. The LS-CAP-1 is suitable for conducting liquids such as water whilst the LS-CAP-2 is designed for use with clean, low viscosity non-conducting liquids, such as oil.

Part Number	Description
Conducting Liquids	
LS-CAP-1-0.5	0.5m Probe
LS-CAP-1-1.0	1.0m Probe
LS-CAP-1-1.5	1.5m Probe
LS-CAP-1-2.0	2.0m Probe
LS-CAP-1-2.5	2.5m Probe
LS-CAP-1-3.0	3.0m Probe

Part Number	Description
Non-conducting Liquids	
LS-CAP-2-0.5	0.5m Probe
LS-CAP-2-1.0	1.0m Probe
LS-CAP-2-1.5	1.5m Probe
LS-CAP-2-2.0	2.0m Probe
LS-CAP-2-2.5	2.5m Probe
LS-CAP-2-3.0	3.0m Probe

LS-UT - ULTRASONIC LEVEL TRANSMITTER

The LS-UT provides accurate level measurement where non-contact level monitoring is the preferred option. The output represents the distance between the surface of the liquid being detected and the transmitter. It has a user programmable measuring range of up to 8 meters.

Part Number	Description
LS-UT	Ultrasonic Level Transmitter

LS-541 - FLOAT SWITCH

The LS-541 is intended to monitor the liquid level in a tank or vessel and provides a switched output for local alarm, pump or valve control. The differential between switching is equivalent to approximately 15mm. The unit mounts into 1" BSPT female boss. Access is not required from the inside of the tank.

Part Number	Description
LS-541	1" BSPT Float Switch (horizontal mount)

LS-FL - LIQUID LEVEL FLOAT SWITCHES

The LS-FL series is a range of level switches suitable for single or multi-level applications where access is only available from the top surface or where multiple level sensing is desired from a single penetration. Units consist of a float, which is suspended from a weighted cable. As the liquid level changes, the float follows the surface level, at the same time tilting due to its weighted restraint. Inside the float are a number of micro switches which trigger as the float tips.

Part Number	Description
LS-FL-1H	High Level, Alarm Switch
LS-FL-1L	Low Level, Alarm Switch
LS-FL-2H	Emptying Pump, Control Switch
LS-FL-2L	Filling Pump, Control Switch
LS-FL-2LH	High & Low Level Alarm Switch

Power Sensors

SWITCHES

- Solid or split-core
- Auto-ranging eliminates lost jumpers
- Self-powered and no insertion loss
- True digital switching with zero leakage
- Small compact size
- Fixed or field adjustable models
- Input / output isolation via current transformer

SENSORS

- Solid or split-core
- No field adjustment necessary, factory calibrated
- 0-5 Vdc or 4-20 mA models
- Average measurements or True RMS
- Input / output isolation via current transformer
- Small compact Size

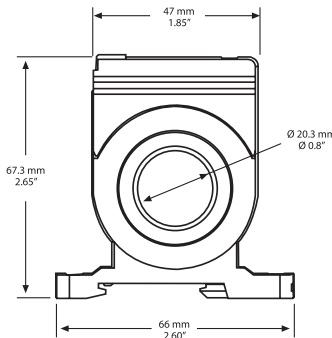

ENCLOSED SOLID CORE CURRENT SWITCH A/MCS VERSION



Part Number	Description
A/MCS	Current Switch, Fixed Version, Solid Core
A/MCS-A	Current Switch, Adjustable Version, Solid Core



ENCLOSED SOLID CORE CURRENT SWITCH RIB VERSION



Part Number	Description
RIBXKTF	Current Switch Fixed Version, Solid Core
RIBXKTA	Current Switch Adjustable Version Solid Core
RIBXGTA-SCAL	Split Core Unique Self Calibrating Current Switch

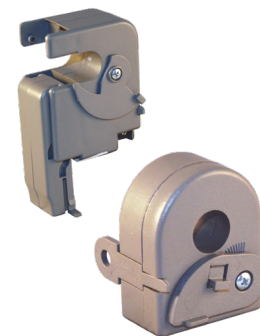

Working Together to Improve Indoor Air Quality

NOW AVAILABLE FROM IBC



06

AIR QUALITY

Contents

Air Quality

DriStream	107
GPS Air	109
Seitron	111
Sontay	119
Industrie Technik	123
Greystone	125
S&S Northern	128



Click the page number to
Navigate to the relevant page

DriSteem Humidification Systems

DriSteem is a premier provider of humidification, evaporative cooling, and water treatment solutions for commercial and industrial applications. DriSteem offers custom systems for critical indoor environments such as health care, data centers, and other facilities requiring precise control of moisture and cooling in the air.

RTS® HUMIDIFIER RX SERIES

The RTS humidifier is loaded with state-of-the-art features that make it stand out against other steam humidifiers on the market. Compatible with all water types including tap, softened, deionized, and reverse osmosis, this unit continuously learns as it runs and automatically adapts to optimize steam output and overall performance.

The new RTS humidifier offers a next generation breakthrough in resistive steam humidifiers, with ease of maintenance, installation flexibility, and environmental protection, while continuing DriSteem's legacy of sustained quality and dependability.

FLEXIBLE

- Capacity from 2.7 to 147 kg/h, link up to 8 units for capacity up to 1176 kg/h.
- Integrated drain water tempering automatically cools discharged hot water to 60 °C.
- Disperses steam through ductwork with dispersion tubes or panels, or directly into a room with a Space Distribution Unit (SDU) mounted remotely or above the RTS humidifier.
- Enclosures for virtually any environment: outdoor or indoor, or factory-HVAC installed.

ACCURATE

- Standard solid-state relay (SSR) operation on every unit.
- Control to $\pm 1\%$ RH.
- Optional mini-drain operation mode allows for 24/7 continuous steam output.

EASY TO MAINTAIN

- DriSteem's smart drain technology adjusts drain intervals automatically based on water quality. Draining removes precipitated minerals from the tank.
- User-adjustable water skimmer skims off floating minerals.
- End-of-season auto-drain minimizes microbial growth.
- Tank bottom is dual sloped with a side exit drain port located at the bottom of the slopes to ensure complete draining of tank.

COMPREHENSIVE CONTROL WITH VAPOR-LOGIC CONTROLLER

The RTS humidifier with the Vapor-logic® touchscreen controller sets new standards for control in electric steam humidification:

- Interoperability allows communication with building automation systems via Modbus® or BACnet® or with optional LonTalk® protocols.
- Safety presets initiate fill and drain cycles and keep the humidifier cool and safe if sensed conditions, though unlikely, could be hazardous.
- Web-enabled control allows you to set up, view, and adjust humidifier functions via Ethernet, either directly or remotely through a network.

driSteem 



RTS humidifier RX series from DriSteem



RTS humidifier RX series with floor stand



IBC stock over 2500 products
ready for immediate delivery



Serving the (BMS & HVAC)
Industry since 2005

driSteem 

Humidi-tech humidifier from DriSteem

HUMIDI-TECH® HUMIDIFIER

The DriSteem Humidi-tech humidifier is a compact, cabinet-style unit compatible with all water types (tap, softened, deionized, reverse osmosis) and numerous dispersion options. Installation is a snap - just attach the frame to a supporting structure and connect electrical and water services.

Available matching Space Distribution Units disperse steam with no visible vapor trail, making Humidi-tech ideal for use in finished spaces.

VERSATILE

- Capacity from 2.7 to 46 kg/h, link up to 16 units for capacity up to 740 kg/h.
- Disperses steam through ductwork with dispersion tubes or panels, or directly into a room with a Space Distribution Unit (SDU) mounted remotely or on top of the Humidi-tech.
- Control to $\pm 3\%$ RH.
- On-off or time-proportioned (TP) control for application control in most environments; solid-state relay (SSR) option for tight control.
- Electronically monitored water level ensures safe and reliable operation.

ULTRA-SORB® MP STEAM DISPERSION PANELS

DriSteem steam dispersion units disperse steam generated by pressurized steam boilers or by non-pressurized steam humidifiers. The steam is distributed through ducts, air handlers, and even directly into finished spaces, where it is released in the airstream.

DriSteem's Ultra-sorb Model MP is a multi-purpose humidifier dispersion panel for both pressurized and atmospheric steam applications in AHUs or ducts.

- Wide steam capacity range, up to 1235 kg/h
- Same side steam inlet and drain for reduced piping and a clean installation in AHUs or ductwork.
- In-frame condensate drain piping maximizes available face dimensions and minimizes blank-off requirements.
- Integral steam header allows clear space on exterior walls of AHUs.

HIGH-EFFICIENCY TUBE OPTION

Ultra-sorb MP steam dispersion panel are available with DriSteem's industry-leading high-performance dispersion tube insulation.

Insulated dispersion tubes produce less condensate, leaving more steam available for humidification, and increasing the capacity of each tube. As a result, fewer tubes may be required to meet application requirements, further lowering condensate production and heat gain while reducing resource consumption and cost.



Ultra-sorb Model MP steam dispersion panel from DriSteem with high-efficiency insulated tubes



DriCalc[®]
Confidently
Specify & Select
Humidification
Systems

driSteem 

THE IMPORTANCE OF INDOOR AIR QUALITY

The relationship between poor indoor air quality (IAQ) and both short- and long-term adverse health effects has long been established. Despite the importance of breathing clean indoor air, many of us are often unknowingly exposed to poor IAQ regularly, underscoring the importance of taking proactive steps to improve IAQ and minimize our exposure to indoor air pollutants. A first line of defense of any comprehensive strategy to address IAQ includes air filters in a building's HVAC system.

IAQ experts recommend using at least MERV-13-rated filters for better filtration of particulate matter (PM). But higher-rated filters present several challenges. First, they are often much more expensive, and the costs of replacing and maintaining them can add up quickly, as filters must be regularly replaced (up to four times a year). Additionally, all filters – regardless of their efficiency rating – often struggle to capture microscopic and submicroscopic particles, including many common viruses and bacteria.

One way to improve filter performance and reduce airborne PM is by adding a complementary air-cleaning technology as part of a multilayered approach. Ionization provides a cost-effective solution that doesn't compromise filter performance or IAQ; in fact, it is shown to improve both.

IMPROVE YOUR INDOOR AIR QUALITY WITH NEEDLEPOINT BIPOLAR IONISATION TECHNOLOGY

GPS® patented NPBI technology works to improve IAQ by targeting airborne particles including certain odors, viruses and bacteria. NPBI technology introduces ions into a space via the existing HVAC system. When these ions disperse throughout a space, they seek out and form bonds with particles in the air through a process called agglomeration. This creates a snowball effect in which particles begin to cluster together. The larger a cluster of particles becomes, the easier it is for an HVAC system to filter it out of the air. In addition to this clustering effect, contact with ions also inactivates certain viruses and bacteria.

DM-2™

The DM-2 is the auto-cleaning NPBI™ system designed for indoor duct mounting. Its low-profile design allows for mounting in proximity to the occupied space, especially when combined with the DM-S™ round-duct mounting accessory.

CI-2™

The CI-2 is an auto-cleaning NPBI system designed to fit where traditional air ionizers don't, including fan coils, PTACs, ductless mini splits, ceiling cassettes and ducted modules, as well as traditional split systems and air handlers up to 2,400 CFM.

GPS-FC24™ -AC

The GPS-FC24-AC is an auto-cleaning, lightweight NPBI system that handles up to 2,400 CFM or 6 tons. Designed for multiple mounting options, including fan inlets, interior duct walls or floors.

GPS-FC48™ -AC

The GPS-FC48-AC is an auto-cleaning, lightweight NPBI system that handles up to 4,800 CFM or 12 tons. Designed for multiple mounting options, including fan inlets, interior duct walls or floors.

GPS-DM48™ -AC

The GPS-DM48-AC is an auto-cleaning, lightweight NPBI™ system that handles up to 4,800 CFM or 12 tons. Design optimized for mounting into interior duct walls or floors.



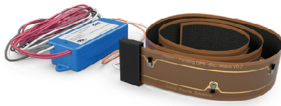

GPS-IRIB®-18/36

The GPS-iRIB is available in 18- and 36-inch lengths. This mechanism is engineered to deliver the highest level of ionization with the least amount of energy in the most compact size.



GPS-iMOD®

The GPS-iMOD is a modular NPBI system that is field-assembled to any length up to 240 inches in 6-inch increments. Designed for mounting in air handling units, the iMOD is ideal for preventing buildup on evaporator coils.

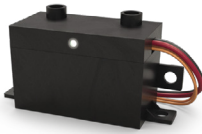

GPS-FC-3-BAS

The GPS-FC-3-BAS unit is designed to be mounted inside of fan coils, heat pumps, PTACs, ductless mini splits and air handlers up to 3,200 CFM or 8 tons. Its compact size and simple mounting requirement allow it to be mounted almost anywhere in just a few minutes.

ACCESSORIES

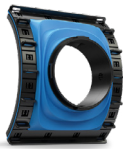

DM-S™

The DM-S is a single, adaptable saddle solution for installing the DM-2™ onto varying round-duct diameters of 6 inches and up. The DM-S saddle installation accessory is sold separately from NPBI™ systems.



PS-2™

The PS-2 is a single-power transformation solution for compatible GPS ionizer products.



GPS-iMEASURE

The GPS-iMEASURE is the first commercially available ion detector that can be permanently mounted in the space to measure ion levels in real time and report back to a building management system.



GPS-iMEASURE-D

The GPS-iMEASURE-D ion detector is permanently mounted in the duct downstream of any GPS® ionization device. It measures ion levels in real time and reports back to a BAS. It includes three sensitivity levels – 20,000, 200,000 or 2,000,000 ions/cc – that can be set based on the application and in-duct location.



GPS-iDETECT-P

The GPS-iDETECT-P is a plenum-mounted ionization detector that confirms the output from the GPS-iMOD® system. The GPS-iDETECT-P provides the ability to monitor ionization status in a plenum to confirm that the ionization equipment is working properly.



GPS-NEMA4-OE

The GPS-NEMA4-OE is a NEMA 4X-rated fiberglass enclosure designed to house one GPS-iMOD power supply. The panel adds a superior finished look to any project while providing the required protection against foreign substances, such as water and dust, when power supplies are mounted in a non-NEMA 1-rated environment.

RESIDENTIAL GAS LEAK DETECTORS

Seitron has been designing and manufacturing gas detectors for civil or domestic use for more than twenty years. From the beginning the choice was limited to 3 gases (2 explosive gases, methane and LPG, and 1 toxic gas, carbon monoxide - CO) and to produce gas leak detectors that deliver the maximum guarantees to those who use them for their own safety:

- Only detectors with acoustic alarm
- Relay output to activate normally closed (N.C.) and normally open (N.O.) electrovalve
- Only detectors powered with 230V mains voltage

BEAGLE & SEGUGIO COMPARISON CHART

Features	Beagle	Segugio
Zone Number	1	2
Natural Gas	RGDME5MP1R, RGDME5MP1T	RGDMETMP1R
LPG	RGDGP5MP1R, RGDGP5MP1T	RGDGPLMP1R
CO	RGDCK5MP1S, RDCBA1	RGDCOKMP1
Kit With 3/4" Gas Electrovalve (NO/NC)	✓	✓
Power Supply	230 V~	230 V~
Acoustic Alarm	✓	✓
Output for 230V~ Gas Ev	✓	✓
Output for 12V= Gas Ev	-	✓
Sensor Life	5 Years	5 Years
Precalibrated replaceable sensor	✓	✓
Instrument Warranty	3 Years	3 Years
Alarm Test Button	✓	✓
Yellow LED for Fault Alarm	✓	✓
Red LED for Gas Alarm	✓	✓
Green LED for Working Unit	✓	✓
Dimensions	L85 x A107 x P38 mm	L148 x A84 x P40 mm

BEAGLE GAS LEAKAGE DETECTOR - METHANE

Domestic methane gas detector with output for driving 230V~ cut-off valves.

Test button. In compliance with CEI-EN 50194-1 standard. IMQ quality mark and compliance with CEI-EN 50194-1 certify the absolute reliability and efficiency of the device. Precalibrated sensor, directly replaceable by user. Pre-calibrated sensor (ACMM01), replaceable directly by the user.

Part Number	Description
RGDME5MP1R	SnO2 Semiconductor Precalibrated sensor, directly replaceable by user
RGDME5MP1T	with 2m cable and plug

Technical Features	Description
Power supply	230V~ -15/+10% 50Hz
Sensor life	5 years
IP rating	IP42
Dimensions	H107 W85 D38mm

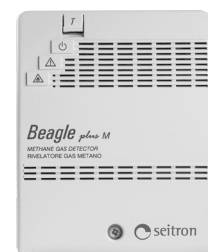

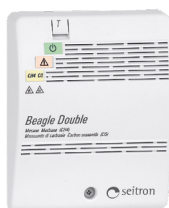

BEAGLE GAS LEAKAGE DETECTOR - LPG

Microprocessor based domestic carbon monoxide detector with output for cut-off valves, fans or any other electrical actuators with 230V power supply. Carbon monoxide detection with accumulation mode: it simulates the gas accumulation in the human body according to standard EN 50291-1. Pre-calibrated sensor (ACMC01), replaceable directly by the user.

Part Number	Description
RGDGP5MP1R	SnO2 Semiconductor Precalibrated sensor, directly replaceable by user
RGDGP5MP1T	with 2m cable and plug

Technical Features	Description
Power supply	230V~ -15/+10% 50Hz
Alarm threshold	10% L.E.L.
IP rating	IP42
Dimensions	H107 W85 D38mm

BEAGLE GAS LEAKAGE DETECTOR - CO

Microprocessor based domestic carbon monoxide detector with output for cut-off valves, fans or any other electrical actuators with 230V power supply. Carbon monoxide detection with accumulation mode: it simulates the gas accumulation in the human body according to standard EN 50291-1. Pre-calibrated sensor (ACMC01), replaceable directly by the user.

Part Number	Description
RGDCK5MP1S	Precalibrated chemical cell on module, directly replaceable by user
RDCBA1	with 2m cable and plug

Technical Features	Description
Power supply	230V~ -±10% 50Hz
Alarm threshold	~30ppm CO lasting for >120 minutes
Button	Test/Alarm reset
Alarm Buzzer	Buzzer 85dB(A)@ 1m
IP rating	IP42
Dimensions	H107 W85 D38mm

BEAGLE GAS LEAKAGE DETECTOR - METHANE AND CO

Domestic methane (CH4) gas and carbon monoxide (CO) detector with facility for driving 230V~ cut-off valves or fans. Test button. Not compliant with EN 50291.

Part Number	Description
RGDCM0MP1	SnO2 Semiconductor

Technical Features	Description
Power supply	230V~ -15/+10% 50Hz
Alarm threshold	10% L.E.L. CH4 80ppm CO
Sensor life	5 years
IP rating	IP42
Dimensions	H107 W85 D38mm

SEGUGIO GAS LEAKAGE DETECTOR - METHANE

Microprocessor based domestic methane gas detector with output for both 230V~ and 12V~/= cut-off valves. Test function. Precalibrated sensor, directly replaceable by user. IMQ quality mark and compliance with CEI-EN 50194-1 certify the absolute reliability and efficiency of the device.

Part Number	Description
RGDMETMP1R	SnO2 Semiconductor Precalibrated sensor, directly replaceable by user

Technical Features	Description
Power supply	230V~ ±10% 50Hz
Sensor life	5 years
Alarm buzzer	85dB (A) @ 1m
IP rating	IP42
Dimensions	H107 W85 D38mm

SEGUGIO GAS LEAKAGE DETECTOR - CO

Microprocessor based domestic carbon monoxide detector with output for cut-off valves, fans or any other electrical actuators with 230V~ power supply. Carbon monoxide detection with threshold mode. Not compliant with EN 50291.

Part Number	Description
RGDCOHP11	Electrochemical cell type internal sensor

Technical Features	Description
Power supply	230V~ -15/+10% 50Hz
Alarm	Buzzer 85dB(A) @ 1m
Pre alarm threshold	16ppm
Alarm threshold	80ppm
IP rating	IP42
Dimensions	H84 W148 D40mm

SEGUGIO GAS LEAKAGE DETECTOR - LPG

Microprocessor based domestic LPG gas detector with output for both 230V~ and 12V~/= cut-off valves. Test function. Precalibrated sensor, directly replaceable by user. IMQ quality mark and compliance with CEI-EN 50194-1 certify the absolute reliability and efficiency of the device. Pre-calibrated sensor (ACMG01), replaceable directly by the user.

Part Number	Description
RGDGPLMP1R	SnO2 semiconductor Precalibrated sensor, directly replaceable by user

Technical Features	Description
Power supply	230V~ ±10% 50Hz
Sensor life	5 years
Alarm Buzzer	85dB (A) @ 1m
IP rating	IP42
Dimensions	H84 W148 D40mm





SEGUGIO GAS LEAKAGE DETECTOR - CO

Microprocessor based domestic carbon monoxide detector with output for cut-off valves, fans or any other electrical actuators with 230V~ power supply. Carbon monoxide detection with accumulation mode: it simulates the gas accumulation in the human body according to standard EN50291.

Part Number	Description
RGDCOKMP1	Electrochemical cell

Technical Features	Description
Power supply	230V~ -15/+10% 50Hz
Button	Alarm Test-Reset
Alarm	Buzzer 85dB(A) @ 1m
IP rating	IP42
Dimensions	H84 W148 D40mm

SEGUGIO GAS LEAKAGE DETECTOR - METHANE + CO

Microprocessor based domestic methane and carbon monoxide detector equipped with two separated output relays with output for driving 230V~ cut-off valves. Sensors assembled on precalibrated modules replaceable by user. Carbon monoxide detection with accumulation mode: it simulates the gas accumulation in the human body according to standard EN 50291-1. Pre-calibrated sensor (ACMC01 CO, ACCM01 METANO), replaceable directly by the user.

Part Number	Description
RDXSM1	CH4 sensor type: SnO2 semiconductor. Pre-calib. sensor, directly replaceable by user CO sensor type: Pre-calibrated sensor on module replaceable by user

Technical Features	Description
Power supply	230V~ ±10% 50Hz
CH4 sensor life	5 years
Alarm	Buzzer 85dB(A)@1m
IP rating	IP42
Dimensions	H84 W148 D40mm

METHANE OR LPG REMOTE SENSOR (ONLY FOR SEGUGIO)

Remote sensor for natural gas or LPG leaks. Semiconductor sensitive element. Sensor life: 5 years. IP30 container.

Part Number	Description
SGAMET	Methane
SGAGPL	LPG

Technical Features	Description
Power supply	6V = .. 12V = from the control unit
Sensor life	5 years
Detectable gas	Methane or LPG
Degree of protection	IP30
Dimensions	A90 L65 P30mm

INDUSTRIAL GAS DETECTION

Seitron designs and manufactures detectors for methane gas, LPG, gas vapors and CO (Carbon Monoxide) for use in commercial premises and the process industry

INTERFACES

4..20mA

Fault in current loop: 0.0 mA

ZERO: 4.0 mA

Full range: 20.0 mA

Maximum resistance applicable as load at current loop output (4..20 mA) when supply voltage is 12V=-15% is 350 ohm.

Relays		Modbus ®	
Supply voltage:	12 Vdc	Interface:	RS485.
Maximum absorption:	80 mA @ 12 Vdc	Parameters:	19200, 8, N, 1.
Contact rating:	3 x 2 A 250 V~ (voltage free)	Communication protocol:	Modbus® RTU

CASE

Plastic Housing		Plastic Housing	
Filter:	Sinterised PE	Dimensions:	W5.3 H4.8 D2.5 in W134 H124 D67 mm
Case:	ABS V0 - ABS HB	Protection rating:	IP54

ATEX metal for N.C. zones		ATEX metal for N.C. zones	
Filter:	Sinterised stainless steel	Dimensions:	W4 H5.3 D2.4 in W100 H134 D60 mm
Case:	Die-cast Aluminum	Protection rating:	IP6X

ATEX metal for C.A. zones		ATEX metal for C.A. zones	
Filter:	Sinterised stainless steel	Dimensions:	W6.5 H4.6 D3.5 in W165 H117 D90 mm
Case:	Die-cast Aluminum	Protection rating:	IP6X





INDUSTRIAL RANGE TRANSMITTERS

Gas	Working Range	Output signal	Certificate	Cod
Methane	50% L.E.L.	4..20mA + Modbus	IMQ 15 ATEX 003 X	SXMX14M1Y
	100% L.E.L.	4..20mA + Modbus	IMQ 15 ATEX 003 X	SXMX16M1Y
LPG	50% L.E.L.	4..20mA + Modbus	IMQ 15 ATEX 003 X	SXGX14M1Y
	100% L.E.L.	4..20mA + Modbus	IMQ 15 ATEX 003 X	SXGX16M1Y
CO	0 .. 500 ppm	4..20mA + Modbus	IMQ 15 ATEX 003 X	SXCX11M1Y

Gas	Working Range	Output signal	Certificate	Cod
Methane	50% L.E.L.	4..20mA	IMQ 20 ATEX 006	SWMX1411
LPG	50% L.E.L.	4..20mA	IMQ 20 ATEX 006	SWGX1411
Hydrogen	20% L.E.L.	4..20mA	IMQ 20 ATEX 006	SWHX1211

COMMERCIAL RANGE TRANSMITTERS

Gas	Working Range	Output signal	Certificate	Cod
Methane	50% L.E.L.	4..20mA + Modbus	metallic	SYMN54B
LPG	50% L.E.L.	4..20mA + Modbus	metallic	SYGN54B
Hydrogen	0 .. 500 ppm	4..20mA + Modbus	metallic	SYCN51B

BASE RANGE TRANSMITTERS

Gas	Working Range	Output signal	Certificate	Cod
Methane	50% L.E.L.	4..20mA + Modbus	grey plastic	SYMN24B
		4..20mA + Modbus + Relè + Buzzer + LED	transparent plastic	SYMN04R
	100% L.E.L.	4..20mA + Modbus	grey plastic	SYMN26B
		4..20mA + Modbus + Relè + Buzzer + LED	transparent plastic	SYMN06R
LPG	50% L.E.L.	4..20mA + Modbus	grey plastic	SYGN24B
		4..20mA + Modbus + Relè + Buzzer + LED	transparent plastic	SY GN 04R
	100% L.E.L.	4..20mA + Modbus	grey plastic	SY GN 26B
		4..20mA + Modbus + Relè + Buzzer + LED	transparent plastic	SYGN06R
CO	0 .. 500 ppm	4..20mA + Modbus	grey plastic	SYCN21B
		4..20mA + Modbus + Relè + Buzzer + LED	transparent plastic	SYCN01R

All transmitters are compatible with the RYM02M0, RYM02M1, RYM02M2, RYK01M control units. There is only one exception: SW-X transmitters do not work with the RYK01M control unit.

INDUSTRIAL CONTROL UNIT FOR 8 ZONES

Industrial control unit for gas detection with 8 zones fit in IP44 capable of monitoring gas concentration up to maximum 8 zones. Possibility of connecting a 4 .. 20 mA transmitter in each zone for the detection of LPG, methane, carbon monoxide (CO) or petrol vapours.

Part Number	Description
RXA01M	Industrial control unit for gas detection with 8 zones

Technical Features	Description
Power supply	230V~ 50/60 Hz or 12Vdc with backup battery
Absorption:	15W max.
Activation time:	60 s.
Input (4..20mA):	1 for toxic gases 5 for flammable gases
Contacts rating:	5x3(1)A 250V~ SPDT
Protection rating:	IP 30 (acc. EN 60529)
Humidity limit:	20% .. 80% RH (non condensing)
Dimensions:	245x100x60 mm (LxHxD)



4 IN 2 OUT + RESET CONTROL UNIT

Control unit for gas leakage sensors; input for up to 4 remote sensors (1). Reset and test pushbuttons. Memory of the alarm state. 2 relay outputs.

Part Number	Description
RGI000MSX4	Control unit for gas leakage sensors

Technical Features	Description
Power supply	230V~ -15/+10% 50Hz
Output (relay)	2x6(2)A @ 250V~ SPDT
Indicators: active/fault/alarm	4 Green LEDs/blinking LED/4 red LEDs
Delay on e.v. relay	1 .. 90 sec.
Button 1	Test
Button 2	Reset
IP rating	IP54
Dimensions	H188 W230 D114mm

Notes: (1) The remote sensor used are: SGAMET, SGAGPL, SGIME1, SGIGP1, SGIME1M, SGIGP1M..
 (2) The back-up battery to be used is ACCSGB12.



IBC stock over 2500 products
ready for immediate delivery



Serving the (BMS & HVAC)
Industry since 2005



2 IN 2 OUT + RESET CONTROL UNIT

Control unit for gas leakage sensors with two relay outputs, inputs for 2 remote sensors (1). Reset button. IP54 case. For Non-classified ATEX zones.

Part Number	Description
RG1001MSX2	Control unit for gas leakage sensors with two relay outputs

Technical Features	Description
Power supply	30V~ -15/+10% 50Hz
Output 1 (relay x e.v.)	4(2)A @ 250V~ SPDT
Output 2 (relay x alarm)	4(2)A @ 250V~ SPST
Indicators: active/alarm1/alarm2	Green/red/red LED
Delay on e.v. relay	~15 sec.
Push button	Reset
Dimensions	H79 W134 D62mm
IP rating	IP 54

Notes: (1) The remote sensor used are: SGAMET, SGAGPL, SGIME1, SGIGP1, SGIME1M, SGIGP1M.
(2) The back-up battery to be used is ACCSGB12.

REMOTE SENSOR

Remote sensor for methane or LPG gas leakages. Semiconductor sensing element. Alarm threshold: 10% L.E.L. . Sensor life: 5 years. IP 54 case. Powered by control unit.



Part Number	Description
SGIME1	Per gas metano
SGIGP1	Per gas GPL

REMOTE SENSOR

Remote sensor for methane or LPG gas leakages. Semiconductor sensing element. Alarm threshold: 10% L.E.L. . Sensor life: 5 years. IP 54 case. 230V~ power supply.



Part Number	Description
SGIME1M	Per gas metano
SGIGP1M	Per gas GPL



Speak with our team
about any large projects



Order before 2pm for
same day dispatch

GS-AQ - INDOOR AIR QUALITY AND TEMPERATURE SENSOR

The GS-AQ series of air quality transmitters determine the air quality through measurement of Total Volatile Organic Compounds (TVOC's). This signal can be used to control fresh air fans and dampers according to the ventilation load. A valuable feature of this sensor is it automatically detects what the controller input is set to, 4-20mA or 0-10Vdc. This removes the requirement for output jumpers that can be inadvertently set incorrectly.

Part Number	Description
GS-AQ-S	Space Mounted Air Quality & Temperature Sensor

Technical Features	Description
Active Outputs	0-10Vdc or 4-20mA (3-wire) self-detecting
Output ranges	Air Quality: 0 to 1,000ppb TVOC Temperature: 0 to 40°C
Power Supply	24Vac/dc ±10%
Protection	IP30
Weight	180g

Part Number	Description
GS-AQ-D	Duct Mounted Air Quality & Temperature Sensor

Technical Features	Description
Active Outputs	0-10Vdc or 4-20mA (3-wire) self-detecting
Output ranges	Air Quality: 0 to 1,000ppb TVOC Temperature: -20 to +20°C
Power Supply	24Vac/dc ±10%
Protection	IP65
Weight	250g

NOTE:

* -T versions use a thermistor element. Please specify type when ordering. When using in space sensors, they are not compensated for self heating.

* Only available on Space Sensor Types.

** Plain front, no user interface option available (SP/MS/LCD)

Part Number	Description
-T *	Direct resistive temperature output
-SP *	11-1kΩ/0-10kΩ setpoint
-MS *	Momentary switch
-LCD	LCD display
-TR	Custom temperature range -20 to +50°C
-5V	Output 0-5Vdc (instead of 0-10Vdc)
-BLK**	Black space housing

Suffixes (add to part code)





GS-AQ-X-UN - SINGLE OUTPUT INDOOR AIR QUALITY SENSORS

A valuable feature of this sensor is its ability to automatically detect what the controller input is set to, 4-20mA or 0-10Vdc. This removes the requirement for output jumpers that can be inadvertently set incorrectly. On board LED indication of which output type is in operation is provided. Also available with a passive resistive output for temperature, along with other passive outputs.

Part Number	Description
GS-AQ-S-UN	Space Mounted Air Quality Sensor

Technical Features	Description
Active Outputs	0-10Vdc or 4-20mA (3-wire) self-detecting
Power Supply	24Vac/dc $\pm 10\%$
Output Range	0 to 10 (0 = good / 10 = poor)
Protection	IP30
Weight	200g

Part Number	Description
GS-AQ-D-UN	Duct Mounted Air Quality Transmitter

Technical Features	Description
Active Outputs	0-10Vdc or 4-20mA (3-wire) self-detecting
Power Supply	24Vac/dc $\pm 10\%$
Output Range	0 to 10 (0 = good / 10 = poor)
Protection	IP65
Weight	250g

ACCESSORIES

Part Number	Part Number	Description
DECOR		Decorators trim plate
GASKET		Insulating gasket (pack of 10)

NOTE:

* -T versions use a thermistor element. Please specify type when ordering. When using in space sensors, they are not compensated for self heating.

* Only available on Space Sensor Types.

** Plain front, no user interface option available (SP/MS/LCD)

Part Number	Description
-T *	Direct resistive temperature output
-SP *	1-11k Ω setpoint
-MS *	Momentary switch
-LCD	LCD display
-BLK**	Black space housing

Suffixes (add to part code)

GS-CO₂ - CARBON DIOXIDE, TEMPERATURE AND OPTIONAL RH & IAQ SENSORS

Using a NDIR sensor for measuring CO₂ concentrations and utilizing ABC (Automatic Baseline Correction) algorithm, they offer excellent long term stability & accuracy. Available with active temperature and RH outputs, as well as other passive outputs and user interfaces. A unique feature of this sensor automatically detects what the controller input is set to, 4-20mA or 0-10Vdc. This removes the requirement for output jumpers that can be inadvertently set incorrectly.

Part Number	Description
GS-CO2-S	Space Mounted Air Quality Sensor
GS-CO2-RHT-S	Space Mounted CO ₂ , RH and T Sensor 0-2000ppm
GS-CO2-AQ-S	Space Mounted CO ₂ , T and AQ Sensor 0-2000ppm

Technical Features	Description
Active Outputs	0-10Vdc or 4-20mA (3-wire) self-detecting
Power Supply	24Vac/dc ±10%
Output Range	0 to 10 (0 = good / 10 = poor)
Protection	IP30
Weight	200g

Part Number	Description
GS-CO2-D	Duct Mounted CO ₂ and T Sensor 0-2000ppm
GS-CO2-RHT-D	Duct Mounted CO ₂ , RH and T Sensor 0-2000ppm
GS-CO2-AQ-D	Duct Mounted CO ₂ , T and AQ Sensor 0-2000ppm

Technical Features	Description
Active Outputs	0-10Vdc or 4-20mA (3-wire) self-detecting
Power Supply	24Vac/dc ±10%
Output Range	CO ₂ : 0-2000ppm. Temperature: 0 to 40°C
Protection	IP65
Weight	250g

NOTE:

* -T versions use a thermistor element. Please specify type when ordering.

When using in space sensors, they are not compensated for self heating.

* Only available on Space Sensor Types.

** Plain front, no user interface option available (SP/MS/LCD)

Part Number	Description
-T *	Direct resistive temperature output
-SP *	11-1kΩ/0-10kΩ setpoint
-MS *	Momentary switch
-LCD	LCD display
-LED	3-Colour LED indication for CO ₂
-5V	Output 0-5Vdc (instead of 0-10Vdc)
-BLK**	Black space housing

Suffixes (add to part code)

Sontay[®]





GS-CO - CARBON MONOXIDE SENSORS

Sontay's range of CO sensors offer real time detection for Carbon Monoxide measurement. A valuable feature of this sensor is when in 3-wire mode it automatically detects what the controller input is set to, 4-20mA or 0-10Vdc. 2-wire loop powering selectable via DIP switch. The long life electrochemical Carbon Monoxide sensor makes it ideal for many applications including underground parking, loading bays and warehouses.

Part Number	Description
GS-CO-S	Space Mounted CO and T Sensor

Technical Features	Description
Active Outputs	0-10Vdc or 4-20mA (3-wire) self-detecting 4-20mA (2-wire) via DIP
Power Supply	24Vac/dc ±10%
Output Range	Carbon Monoxide 0 to 500ppm Temperature 0 to 40°C
Protection	IP30
Weight	200g

Part Number	Description
GS-CO-D	Duct Mounted CO and T Sensor

Technical Features	Description
Active Outputs	0-10Vdc or 4-20mA (3-wire) self-detecting 4-20mA (2-wire) via DIP
Power Supply	24Vac/dc ±10%
Output range	Carbon Monoxide 0 to 500ppm Temperature 0 to 40°C
Protection	IP65
Weight	250g

NOTE:

* -T versions use a thermistor element. Please specify type when ordering. When using in space sensors, they are not compensated for self heating. This range of Carbon Monoxide Sensors is designed for monitoring purposes and should not be used in safety applications.

* Only available on Space Sensor Types.

** Plain front, no user interface option available (SP/MS/LCD)

Part Number	Description
-T *	Direct resistive temperature output
-SP *	11-1kΩ/0-10kΩ setpoint
-MS *	Momentary switch
-TR	Custom temperature range -20 to +50°C
-5V	Output 0-5Vdc (instead of 0-10Vdc)
-BLK**	Black space housing

Suffixes (add to part code)

CO₂, CO, VOC TRANSMITTERS

This series with automatic calibration sets new standards in CO₂ measurement for HVAC applications. It combines the measurement of the carbon dioxide level, temperature and relative humidity. Models with or without display are available.

Part Number	Description	Output signal	Accuracy, temperature
TCO2A	CO ₂ + °C	0...10 V + 0...10 V	± 0.4 °C
TCO2A-D	CO ₂ + °C	0...10 V + 0...10 V	± 0.4 °C
TCO2A-M	CO ₂ + °C	Modbus	± 0.4 °C
TCO2A-D-M	CO ₂ + °C	Modbus	± 0.4 °C
TCO2AU	CO ₂ + °C + RH	0...10 V + 0...10 V + 0...10 V	± 0.4 °C
TCO2AU-D	CO ₂ + °C + RH	0...10 V + 0...10 V + 0...10 V	± 0.4 °C
TCO2AU-M	CO ₂ + RH + °C	Modbus	± 0.4 °C

Full range of configurations available on request

Technical Features	Description
Supply voltage	24 V AC ± 10 %, 50...60 Hz / 15...35 V DC
Working range, CO ₂	0...2000 ppm
Working range, temperature	0...50 °C
Working range, humidity	10...90 % RH (non-condensing)
Relay output	Max. 1 A at 50 V AC, min. 1 mA at 5 V DC
Protection class	IP30

CO₂ TRANSMITTER, AIR DUCT MOUNTING

Measures the concentration of carbon dioxide in ducts. Exempt from periodic calibration. Some models are equipped with a passive temperature sensor.

Part Number	Description	Output signal	Accuracy, temperature
TCO2C	CO ₂	0...10 V	-
TCO2C-05	CO ₂	0...5 V	-
TCO2C-PT100	CO ₂ + PT100, 100 Ohm (0°C)	0...10 V + Ohm	± 0.3 °C
TCO2C-NTC10-01	CO ₂ + NTC 10, 10 kOhm (25°C)	0...10 V + Ohm	± 0.2 °C

Full range of configurations available on request

Technical Features	Description
Supply voltage	15...35 V DC / 24 V AC ± 10% 50-60 Hz
CO ₂ sensor	NDIR (Non-Dispersive Infrared Technology)
Output	0...10 V DC or 0...5 V DC, RL > 10 kOhm
Working range, CO ₂	0...2000 ppm
Working range, temperature	0...+50 °C
Working range, humidity	10...90 % RH (non-condensing)
Max. air velocity	10 m/s
Insertion length	60...230 mm
Dimensions	75 x 77 x 36 mm (housing)
Protection class	IP65 case (sensor excluded)





CARBON MONOXIDE TRANSMITTER

This device measures the carbon monoxide concentration using an electrochemical method of measurement characterised by high selectivity even in low concentrations. It is installed for both safety and energy-saving reasons. The output signals are linear representations of the gas concentration.

The transmitter is TÜV-approved in accordance with VDI 2053.

Part Number	Description
TCO1	CO transmitter

Technical Features	Description
Supply voltage	12...28 V DC
Measuring range	0...300 ppm
Outputs	4...20 mA, two-wire / 0...10 V DC, three-wire
Calibration	Automatic zero adjustment
Dimensions	80 x 82 x 86 mm
Protection class	IP56

ROOM AIR QUALITY TRANSMITTERS, VOC

Analysis of the air quality based on a mixed gas VOC (Volatile Organic Compounds) sensor.

Detectable gases:

- carbon monoxide CO
- hydrogen sulfide H₂S
- solvent vapours
- cigarette smoke
- car exhaust
- air produced by human breathing
- combustion smoke from wood, paper and plastics.



Part Number	Description	Application
DB-RLQ	0...10 V DC, 0...20 mA, 4...20 mA	Room
DB-RLQ5	0...5 V DC, 0...20 mA, 4...20 mA	Room

Technical Features	Description
Supply voltage	15...36 V DC or 24 V AC/DC ± 10%, 50-60 Hz
Outputs	0...10 V DC, 0...20 mA or 4...20 mA, selectable by jumpers
Sensor	VOC
Ambient temperature	0...50 °C
Ambient humidity	10...90 % RH (non-condensing)
Storage temperature	-20...+50 °C
Storage humidity	< 95 % RH
Casing	Plastic material similar to RAL 9010
Weight	80 g
Dimensions	75 x 75 x 25 mm
Protection class	IP30 (case)
Isolation class	III
Certification	EN 60335-1: safety / EN 60529: IP degree of protection / EN 60730: domestic controls

AIR QUALITY & GAS

A comprehensive selection of air quality & gas measuring products that are designed and manufactured for long-term stability and performance. Each product provides a repeatable and accurate output signal for efficient air quality & gas monitoring and control.

CARBON DIOXIDE

CE, CD, CDD4 Series

FEATURES

- Menu driven set-up
- 0-2,000 scalable to 20,000 PPM CO₂
- NDIR, dual channel
- Optional temperature sensor outputs
- Guaranteed 5 year calibration interval
- Easily field calibrated

PRODUCT TYPES

- Room
- Duct
- Outside



CARBON DIOXIDE, TEMPERATURE AND HUMIDITY

CDD3, CDD5, CHT Series

FEATURES

- Outputs CO₂, Temperature, & RH Levels
- Menu driven set-up
- 0-2,000 scalable to 10,000 PPM CO₂
- NDIR, dual channel
- Guaranteed 5 year calibration level
- Easily field calibrated
- Analog, BACnet® or Modbus output

PRODUCT TYPES

- Room
- Duct

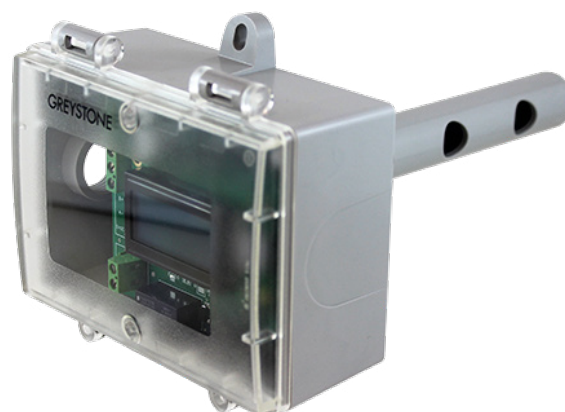

Speak with our expert
BMS engineers today



Online training available
please speak with our team



PARTICULATE MATTER

PM Series

FEATURES

- Selectable PM1, 2.5, 4 & 10 Particle Sizes
- 0 - 1000 ug/m3 range
- LCD displaying PM level
- Tri-color LED to indicate IAQ level
- Analog, BACnet® or Modbus output
- Field replaceable sensor

PRODUCT TYPES

- Room
- Duct
- Outside



CARBON MONOXIDE/ NITROGEN DIOXIDE

GDT, CMD, NDD Series

FEATURES

- selectable ranges up to 500 ppm CO or 10 ppm NO2
- Single or dual gas monitoring
- Combination or remote sensor
- Replaceable electrochemical sensing pods
- Analog, BACnet® or Modbus output
- Optional alarm relays with field adjustable trip point
- Optional audible and visual alarm indication
- Optional temperature output
- Easy to calibrate in the field

PRODUCT TYPES

- Surface
- Duct



	Part Number	Description
Product	CMD5B1	Wall/Surface Mount Carbon Monoxide Detector
Relay Option	000 100	No Relay With Relay (Not available with Modbus communications)
Options	- 010 MOD	Leave blank for 4-20 mA 0-10 Vdc output Modbus communications



IBC stock over 2500 products
ready for immediate delivery



Serving the (BMS & HVAC)
Industry since 2005

DUCT SMOKE DETECTOR

DSD Series

FEATURES

- Simple change-out of photoelectric detector heads
- Low flow air velocity rating from 100 to 4000 FPM
- UL, CSFM, and MEA listed
- Two sets of 10A form "C" alarm contacts
- One set of 10A form "C" trouble contacts
- Clear cover for convenient visual inspection
- Built-in reset switch/alarm test switch

PRODUCT TYPES

- Duct

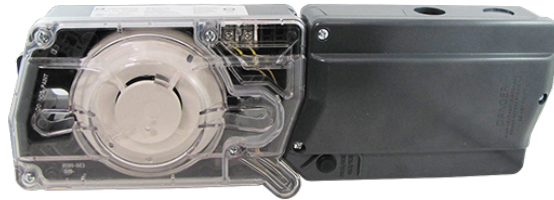

	Part Number	Description
Product	DSD	Duct Smoke Detector, Photoelectric
Power Supply	120 240	120 Vac, 24 Vac/Vdc 240 Vac, 24 Vac/Vdc

	Part Number	Description
Product	DST-	Metal Duct Sampling Tube for DSD Series
Power Supply	1.0 1.5 3.0 5.0 10.0	Duct widths up to 305mm (12") Duct widths between 305mm - 610mm (12" - 24") Duct widths between 610mm - 1200mm (24" - 48") Duct widths between 1200mm - 2400mm (48" - 96") Duct widths between 2400mm - 3700mm (96" - 144")

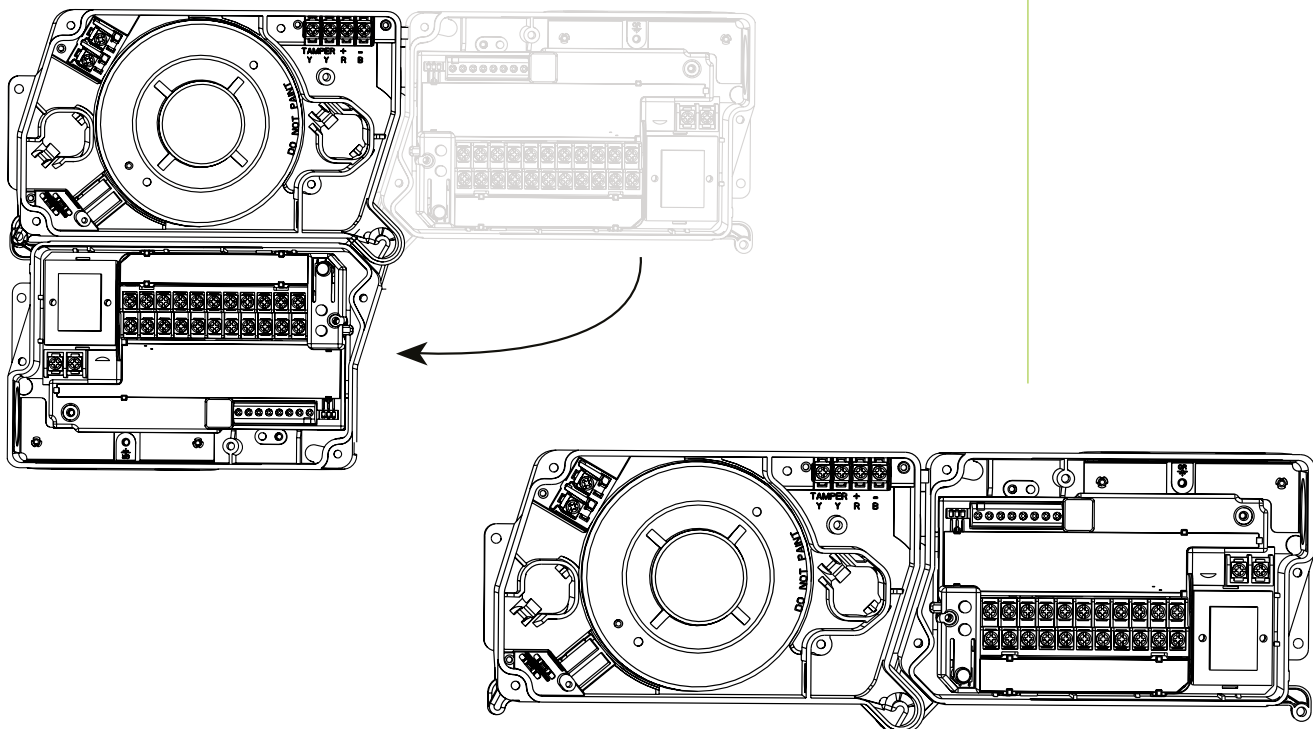



GAS DETECTION & ISOLATION CONTROLLERS

S&S Northern have a solution for every commercial Plant room application. We offer a wide range of control panels, gas detectors, heat sensors and gas solenoid valves. Whether your project is a small residential application or a large scale plant room we have the knowledge and experience to offer the perfect products. Remote monitoring, Modbus and data logging are available on our GDPX Range.

Part Number	Description
1000BH	2 Zone gas detection & gas proving system

FEATURES

- 2 zone gas detection system for up to 6 gas detectors
- Can accept inputs from remote push buttons, fire alarms & heat detectors
- Built-in connectivity to existing BAS/BMS system
- Gas pressure proving - low & high pressure shut off

Part Number	Description
GDP2	2 Zone gas detection system
GDP2X	8 Zone gas detection system

FEATURES

- 8 zone gas detection system for up to 8 gas detectors
- TFT screen displays live gas levels & system indications (GDP2X only)
- Can accept inputs from remote push buttons, fire alarms & heat detectors
- Built-in connectivity to existing BAS/BMS systems

Part Number	Description
TFT CO/NG	Dual gas detection system - TFT colour screen CO & Nat Gas
TFT CO/LPG	Dual gas detection system - TFT colour screen CO & LPG

FEATURES

- Emergency Shutdown of Gas & Boilers
- Compact Adaptable Design provides safety and assurances
- Individual relay outputs per gas
- Clear digital display
- Can accept inputs from remote push buttons, fire alarms & heat detectors

Part Number	Description
IBC 1/2" GAS VALVE	230v 4 Test Point Gas Solenoid
IBC 3/4" GAS VALVE	230v 4 Test Point Gas Solenoid
IBC 1" GAS VALVE	230v 4 Test Point Gas Solenoid
IBC 1 1/4" GAS VALVE	230v 4 Test Point Gas Solenoid
IBC 1 1/2" GAS VALVE	230v 4 Test Point Gas Solenoid
IBC 2" GAS VALVE	230v 4 Test Point Gas Solenoid

FEATURES

- IP54 Rated
- LED indicator when powered
- Have 1/4" BSP downstream port for our gas proving systems

EDUCATION / SCIENCE LABORATORY GAS PROVING

S&S Northern have a range of gas proving systems for educational establishments. Our systems protect Laboratories, food tech and design tech classrooms. We also have products that protect laboratories that have speciality or high pressure gases.

Single, Dual or Triple utility gas pressure proving & isolation system designed specifically for use in School and University Laboratories. Most commonly used to control gas, electric & water.

Part Number	Description
1000V	Gas proving & optional ventilation Interlocking c/w pressure transmitter
1000V+	Gas proving, electrical isolation & optional Ventilation interlocking c/w pressure Transmitter
1000VW+	Gas proving, electrical isolation & optional Ventilation interlocking c/w pressure Transmitter

The pressure transmitter provides a pressure drop analysis on the gas line upon each activation of the gas proving system. This ensures all gas taps and appliances are closed before gas into the space. The pressure drop test also ensures all pipe work is intact and free from fault or damage. this simple 30 second test provides a unique safe start up environment for the user.

Part Number	Description
Pressure Transmitter	Gas pressure proving transmitter (supplied With all merlin gas proving systems)
EM STOP BUTTON	Remote em stop button yellow, shrouded c/w Reset key

KITCHEN VENTILATION INTERLOCKING SYSTEMS

S&S Northern have a range of gas interlock and environmental monitors to meet all of the latest gas and ventilation regulations for commercial kitchens. We have industry leading range of products, from a simple gas interlock system to our advanced demand controlled kitchen ventilation systems and environmental monitors.

Ventilation interlock system specifically designed for use in commercial kitchens to meet BS6173

Part Number	Description
2000S	Gas Ventilation Interlock - Gas Proving - Air PD & Current Sensing C/W Pressure Transmitter
CT1250	Gas Ventilation Interlock With Two Built In Current Monitors
CT1200S	Gas Ventilation Interlock - Air PD Compatible
PM2+	2 Channel current sensor for merlin interlock panels

Part Number	Description
930-80	Air PD Switch 20-300 PA
DUCT KIT	To Suit 930-80



Speak with our team
about any large projects



Order before 2pm for
same day dispatch

TERMS & CONDITIONS OF BUSINESS

1 Preamble

1.1 Definitions in these conditions:

The "Customer" shall mean the corporate entity, firm, partnership, or person seeking to purchase Goods from the Company.

The "Company" shall mean Intelligent Building Controls Limited (IBC).

The "Contract" shall mean any contract of Goods or Services made between the Company and the Customer; the "Goods" shall mean the products articles or things to be sold by the Company.

The headings to the clauses shall not affect the construction of these conditions.

The use of plural shall include the singular and the use of the singular shall include the plural.

1.2 These conditions shall be incorporated into every transaction made between the Company and the Customer

1.3 These conditions shall apply to the exclusion of any terms or conditions put forward by or on behalf of the customer and in the event of any conflict or inconsistency between these terms and conditions of trading and the terms of your order, these terms and conditions prevail, unless otherwise agreed by the Company in writing.

1.4 These conditions shall not create any agency or partnership between the Company and the Customer or any third party

1.5 No person in the employment or acting otherwise as agent of the Company or purporting so to do has authority to accept orders or supply goods in any condition other than those contained herein or to vary these conditions in any way whatsoever. Previous dealings between the Company and the Customer shall not vary or replace these conditions or be deemed in any circumstances whatsoever so to do.

1.6 No purported variation or waiver of or addition to these conditions, whether written or oral or in respect of representations or statements made, shall have effect unless and until authorised in writing by a Director of the Company.

1.7 Quotations, whether written or oral, submitted by the Company shall be deemed to be an invitation to treat and not an offer.

2 Acceptance

2.1 Any quotation issued by the Company shall be open for acceptance at any time during the validity period stated. If unstated the validity period is 30 calendar days. After the expiration of the validity period the quotation is deemed to be withdrawn by the Company.

2.2 Any quotation is made on the understanding that it will be accepted in full. In the event of partial acceptance of the quotation by the Customer a written revised quotation may be sent by the Company to the Customer. Any description or specification or drawing or accompanying the quotations or contained in the Company's marketing material shall not form part of the Contract.

2.3 It is the Customer responsibility to check quotation and order documentation to ensure it is correct and notify the Company of any discrepancies in writing immediately.

2.4 Additions or alterations to orders, however made, shall not be binding until confirmed by the Company in writing.

2.5 The Company reserved the right to change products, specifications, or prices without prior notice.

3 Prices

3.1 The Company reserves the right to change/alter the unit price anytime without notice.

3.2 The quoted price is valid for 30 calendar days from date of issue.

3.3 All prices quoted are net and subject to VAT at the rate prevailing at the date of dispatch.

3.4 If the Customer requires alteration to the order, the price will be varied accordingly, and the Company shall be entitled to recover any ancillary costs incurred.

3.7 Discount (by negotiation) is offered for payment with order and/or prior to delivery.

3.8 Minimum order value is one hundred Euro (€100.00).

4 Damages, property, risk & theft

4.1 The risk in goods supplied by the Company shall pass to the Customer where the Company delivers goods, or the Customer collects the goods.

4.2 The legal and beneficial ownership remains with the Company until payment is received in full.

5 Delivery

5.1 The customer must examine the goods and notify the company of any defects or shortages within 3 working days of delivery.

5.2 Goods lead-in times may vary from product to product and may be outside the control of the Company.

5.3 The Company does not accept any liability for any delays caused by late delivery of goods. However, the Company will endeavor to inform the customer of any unexpected delays.

5.4 Any alterations on the order by the customer may delay the completion and delivery of the order.

5.5 The cost of delivery is included in the quotation unless otherwise stated.

5.6 If the Customer is not available or unable to accept delivery the company may leave the goods on the premises/site but only on foot of written instructions to do so and without any responsibility for loss or damage to the Company.

5.7 If Proof of Delivery is required it must be requested within 3 working days of delivery. There will be an additional charge for this on a customer by customer negotiated basis.

6 Payment

6.1 Queries relating to invoices must be made as soon as practicable but not less than three [3] working days from receipt of invoice

6.2 Where credit facilities have been arranged all monies are due for payment within the agreed number of days from month end. Failure to strictly comply with credit terms will result in normal trading being suspended, with account being designated 'On Stop' and all further orders put on a payment with order basis.

6.3 Customers are required to settle their credit account by electronic funds transfer (EFT). Refer section 13 below.

6.4 Amounts outstanding beyond agreed credit terms will attract interest at the rate of 1.5% per month or part thereof and will be effective from date of invoice(s).

6.5 If no specific credit terms have been agreed then the customer shall pay all sums due to the company either with order or upon delivery.

6.6 We accept payment via MasterCard, Visa, Laser and PayPal. Please note that all payments are processed by third party service providers and the company does not retain any payment details.

7 Guarantee & Warrantee

7.1 All goods supplied are in accordance with and limited to manufacturers terms and conditions EXCEPT in the case of ZIP Heaters (UK) Ltd where warranty is in respect of parts only and this guarantee or warranty is limited to such warranty or guarantee as

is provided by the manufacturer. Such warranties and guarantees are set out in manufacturers and company websites, brochures, catalogues, and quotations.

- 7.2 The company's liability under clause 7.1 above is conditional upon:
- Notice in writing being given to the company immediately the defect or failure arises and detailing the nature of the issue e.g., date, time, place, operating conditions, precise nature of the defect/fault.
 - Goods have been installed in proper and satisfactory manner
 - Goods having been maintained & serviced in a proper and satisfactory manner with documentary evidence.
 - Goods having been used reasonably for the purposes for which they were supplied and not having been damaged by other parties or otherwise or modified in any way.
 - The customer having complied in all respect with all terms and conditions of these conditions of sale.
- 7.3 If alterations/modifications are made to the goods without the prior written consent of the company, the company shall be under no liability for failure of the goods. No allowance shall be made for any alterations so made.
- 7.4 All defective parts replaced shall become the property of the company.
- 7.5 If agreed payment terms are not complied with then any guarantee or warranty issued by the Company is void.

8 Limitations of liability

- 8.1 Except where expressly contained in these conditions of sale, all warranties, conditions, undertakings, and representations, express or implied, statutory or otherwise, are excluded and the company has no obligation, duty or liability in contract, tort (including negligence or breach of statutory duty) or otherwise.
- 8.2 In any event, the company's liability arising for any reason in connection with this contract shall be limited to the original invoice value of goods.
- 8.3 In no circumstances will be the company be liable in contract, tort (including negligence or breach of statutory duty) or otherwise for loss (whether direct or indirect) of profits, business, or anticipated savings.
- 8.4 Each provision of this condition is to be constructed as a separate limitation applying and surviving even if for any reason one or other of the said provisions is held unreasonable in any circumstances and shall remain in force notwithstanding termination of this contract.

9 Cancellation and Returns

- 9.1 The company will not accept cancellation of orders for goods specified uniquely to customer's requirements (customized).
- 9.2 In the event that a purchase has been placed, acknowledged, and confirmed and the order is cancelled any time prior to dispatch, a cancellation fee of 25% is payable.
- 9.3 Orders shall not be cancelled or amended unless so agreed in writing and upon terms which provide indemnity against any loss incurred by the company because of cancellation.
- 9.4 Return of goods will be subject to a re-stocking fee of 30% or as may be agreed but must be confirmed in writing and signed by manager

10 Changes to terms and conditions

- 10.1 The company reserves the right to change these conditions of sale at any time. Any changes being made will be notified in writing via email to the customer in advance of said changes taking effect.

11 Notices

- 11.1 Any notice required to be given in writing under the contract shall be given either by facsimile transmission or via email and shall be deemed to have been delivered (in the absence of evidence to the contrary) within 1 working day of sending.

12 Title

- 12.1 The Customer expressly agrees, that until the Company has been paid in full for the goods comprised in this or any other contract between the parties hereto the following conditions shall apply:
- Risk in the Goods shall pass on delivery, but the goods shall remain the Company's property.
 - The Company reserves the right to dispose of the goods until payment in full for all the goods has been received by the Company in accordance with the terms of this contract or until such time as the Customer sells the goods to its customers by way of bona fide sale at full market price.
 - If Payment due to the Company under this Agreement is overdue in whole or in part the Company may (without prejudice to any of the Company's other rights) recover or re-sell the goods or any part of them and may enter upon the Customer's premises personally or through the Company's servants or agents for that purpose.
 - Until such time as the property in the goods passes to the Customer, the Customer shall be entitled to resell or use the goods in the ordinary course of its business. The Customer shall hold the proceeds of sale (and/or the proceeds of any insurance where appropriate) of any goods upon trust for the Company as to the proportion thereof representing the price and shall account to the Company for same. The Customer shall hold all such monies in a separate bank account pending payment to the Company and shall always keep these monies separate from any monies or property of the Customer or third parties.
 - Until the property and the goods has passed from the Company to the Customer shall ensure that the goods and any products in which they are incorporated are kept in good condition and repair and shall keep such goods and products insured against all risks to their full replacement cost.
 - In case of default in payment the Company shall be granted access rights to repossess the Goods.

13. IBC Bank Account Details

Euro Payments

Bank Account Name:	Intelligent Building Controls Ltd
Bank Account Number:	80646046
Sort Code:	90-00-17
IBAN:	IE08 BOFI 9000 1780 6460 46
Swift/BIC:	BOFIIIE2D

Sterling Payments

Bank Account Name:	Intelligent Building Controls Limited
Bank Account Number:	69816630
Sort Code:	90-23-38
IBAN:	GB69 BOFI 9023 3869 8166 30
Swift/BIC:	BOFIGB2B

Scan the QR code
to complete our
online Credit Account
Application Form



Ireland

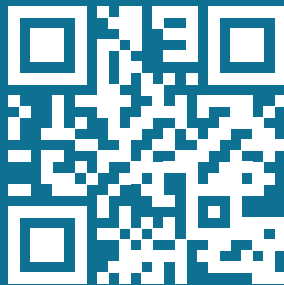

T +353 (0)1 457 5421
E: sales@ibc.ie

N. Ireland / UK



T +44 (0) 7730 700 006
E: bill@ibc.ie

Intelligent Building Controls
Unit 10, Block A, Oak Road Business Park
Oak Close, Dublin 12, D12C920, Ireland